

# KING

*Motorsports*



*Honda/Acura Performance*

## Table Of Contents

Valvetrain Components for 1.6 DOHC Engine	1
Internal Engine Components for 1.6 DOHC Engine	5
Transaxle Components for 1.6 DOHC Engine	8
Suspension CRX/Civic & Integra	10
Exhaust Manifolds	13
Exhaust Pipes & Silencers	14
Valve Train Components for CRX/Civic	15
Integra Pistons & Camshafts	16
Mugen CF-48 Wheels	17
Mugen Body Kits	20
Racing with KMS	21 & 22
88/89 CRX/Civic Performance Accesories	23A, B, C, D
Mugen Accessories: Steering Wheels, Decals & Shirts	23
KMS Pistons	24
KMS Valve Train Components	25
KMS Induction Systems	26
KMS Cranks, Carrillo Rods	27
KMS Transaxle Components	28
Ultra Ignition Wires, CRX Oil Cooler, Quick-Steer Rack	30
HKS Exhaust, Tokico Struts, Sport Spring Kits	31A,B
KMS Brake Components	31
Redline Oil Products	32
New Mugen Decals, Emblems	32
O.E.M. Replacement Parts	33

Store Hours: 9-5 Monday thru Friday  
Central Standard Time

### **WE'VE MOVED**

NEW ADDRESS:

### **King Motorsports**

105 East Main Street

Sullivan, WI 53178

Phone:

414/593-2800

FAX:

414/593-2627

*King Motorsports brings you the next generation in Honda and Acura performance. We do not believe in the term "good enough". We produce and sell what we, and many others, feel is the ruler by which all others in the Honda and Acura performance industry are measured - simply put, the best!*

*King Motorsports was established in 1981 as King Honda Racing with the purchase of a SCCA GT-4 Civic. After extensive re-engineering and rebuilding, the car, driven by Jim Dentici, rocked the racing establishment. With many lap records and National wins, Jim won Honda's first National Championship. In 1985 we left SCCA National competition and built the first Honda to compete in the IMSA Radial Sedan series. This car consistently ran in the top 10 of this tough professional series. Through these efforts we attracted the attention of American Honda and Mugen Co., Ltd. This led to the construction of two Acura Integras which have run in the top 5 for the past two seasons.*

*Of the many lessons learned through our racing efforts, we came to understand how critical it is to have parts that not only perform, but are also durable at the stress level that racing demands. It means literally, the difference between winning and losing. The undisputed leader in Honda and Acura performance and racing components is Mugen Co., Ltd. We are very proud to have been chosen as their sole United States "Authorized Mugen Parts Distributor".*

*For the first time in the Honda performance industry O.E.M. style parts and technology are available to you. Also included in this catalog are competition products manufactured by King Motorsports and products we use and trust.*

*Our philosophy is quite simple: to provide you with the very best products money can buy. We also feel our obligation to you is not over once you receive the parts, but we are able to provide you with the technical help & knowledge so sorely missing from the Honda and Acura aftermarket. You will not hear, "They all do that," or, "Never had that happen before."*

*If you don't see a product you need, please call us. There are new and exciting products being released weekly. You will also be receiving new product updates throughout the year. If you've always dreamed of being in the winner's circle, let King Motorsports put you there !*



## 1600 DOHC Head Assembly (exploded view)

86-89 Integra

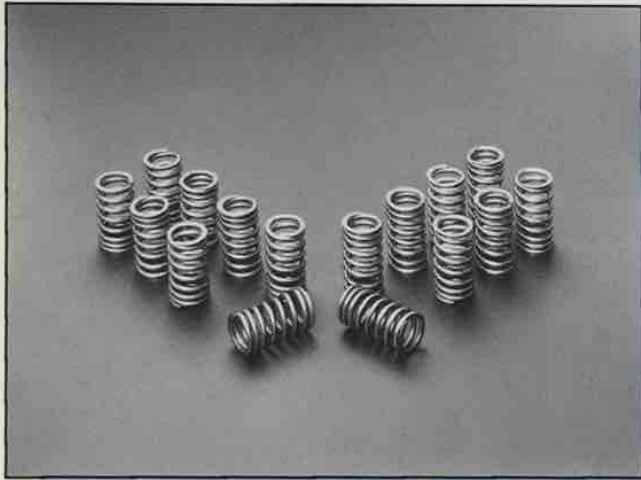
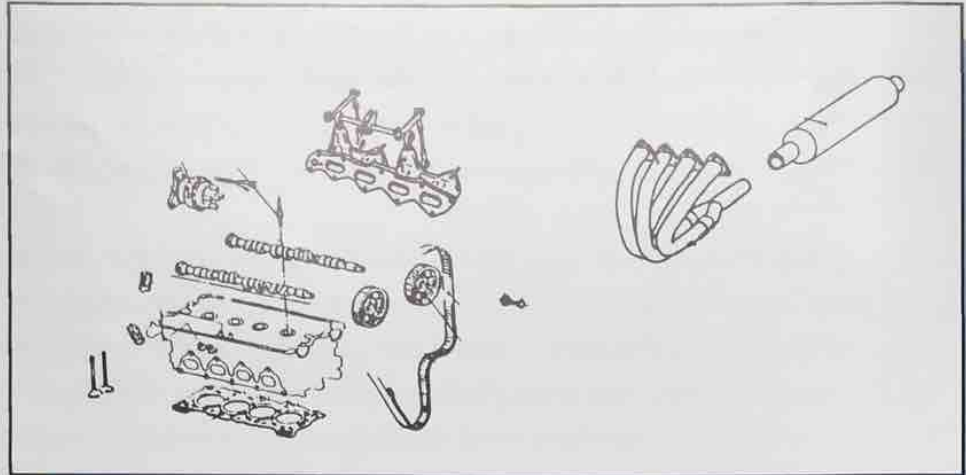

## Valve Spring Set

This valve spring set was designed in conjunction with the Mugen camshaft set. In all the Group A Hondas and IMSA Integras these valve springs have proven to be stable throughout the RPM range. This kit is required when using Mugen camshaft sets because coil bind will occur when the stock valve springs are utilized.

14760-XB2-SORA

## Competition Camshaft Set

Mugen has spent many hours on the dyno in the design of their competition camshaft profiles to assure you of the maximum horsepower possible. Cast iron was chosen as the best possible billet material, and each camshaft is cast in a special mold designed for each particular application. In addition to this, all Mugen camshaft sets are designed with the Honda design formula to keep them in balance with other valve train components (like rocker arms, valves, & valve springs).

14100-XB2-SORA

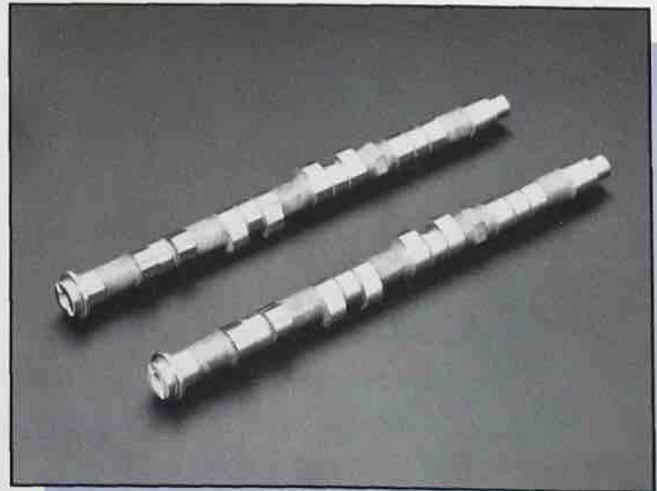



## Polished Valve Set

Mugen uses these valves in all the Group A Hondas and IMSA Integras with tremendous results. These valves are lightened and utilize highly polished surfaces to enhance volumetric efficiency and reduce carbon build-up.

Please remember – regular cylinder head cleaning is a must for maximum horsepower.

14710-XB3-SORJ

## Adjustable Cam Pulley

When you mill your cylinder head or deck your engine block to achieve compression, you in turn upset your valve timing causing a loss in horsepower. Mugen has designed these pulleys with three extra keyways to allow for adjustability of cam timing. These pulleys have proven to be extremely reliable under the stress of racing.

EXHAUST-14212-XB2-OORA INTAKE-14211-XB2-OORA

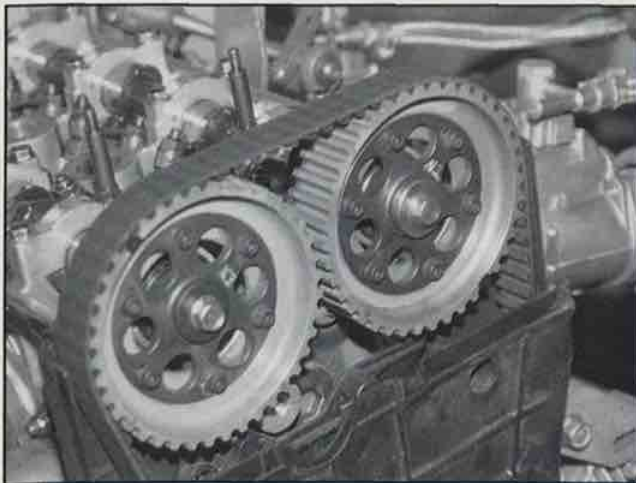
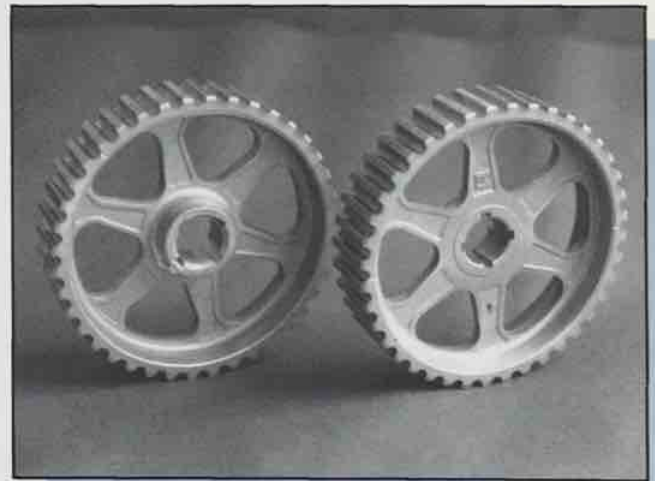

## Slotted Cam Pulley

When a wider range of adjustability is needed for engine development Mugen Slotted Cam Pulleys are a necessity. These aluminum pulleys are cast from a special die and are very easy to adjust. They are also strong enough for racing.

14210-XB3-OORS

page 3

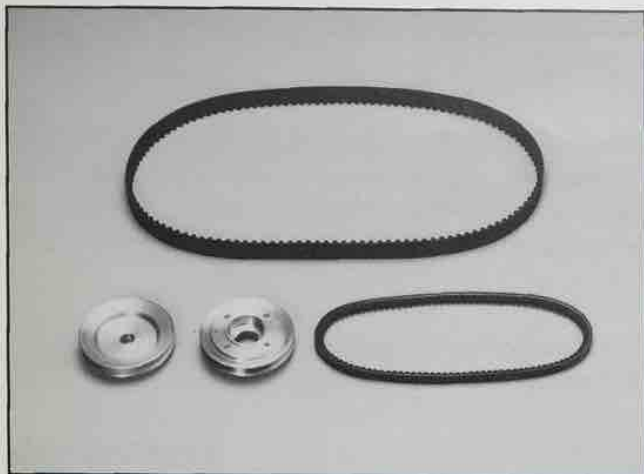

## Timing Belt

When you deck your engine block and mill your cylinder head more than a combined total of 3.5mm, it becomes necessary to use this Mugen Timing Belt. This timing belt is shorter than the stock unit and will eliminate excess slack that cannot be taken out with the timing belt adjusters.

14400-XB2-OORA

## Intake Manifold

This intake manifold was designed specifically for IMSA racing. The length of the intake runners was decided on after many hours of dyno and research work. Included with each kit is a special Mugen throttle linkage which uses high quality ball joint linkages. This linkage is extremely precise and will also accept the standard throttle cable without modification. Although this kit carries a high price tag, the quality of construction and materials used are unsurpassed in the industry.

17000-XB3-KORS

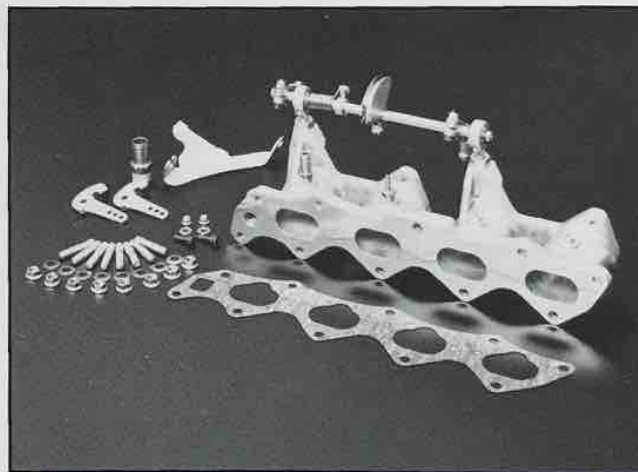

## Exhaust Manifold

After extensive dyno work and research, Mugen has produced this exhaust manifold for IMSA or SCCA GT-3 racing. Each exhaust manifold is hand-crafted and is sand-bent to assure no tubing size reductions, after which each manifold is carefully TIG welded for optimum strength. The result is an exhaust manifold which is not only strong, but produces maximum horsepower.

18100-XB3-OORJ

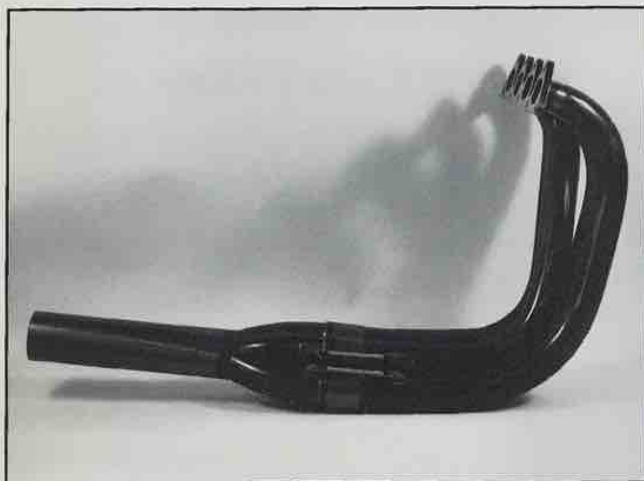

## Metal Head Gasket

Under the stress of high RPM and high-compression use, the stock head gasket can fail. Mugen constructs this Metal Head Gasket from stainless steel. This is the exact material and construction Honda uses for its Formula-One engines, which see tremendous stress without failure. These Metal Head Gaskets have better elasticity at high temperatures and they also add to the engine's stiffness. Available for 75mm or 76mm overbore.

75mm-12251-XB2-OORA 76mm-12251-XB3-OORU

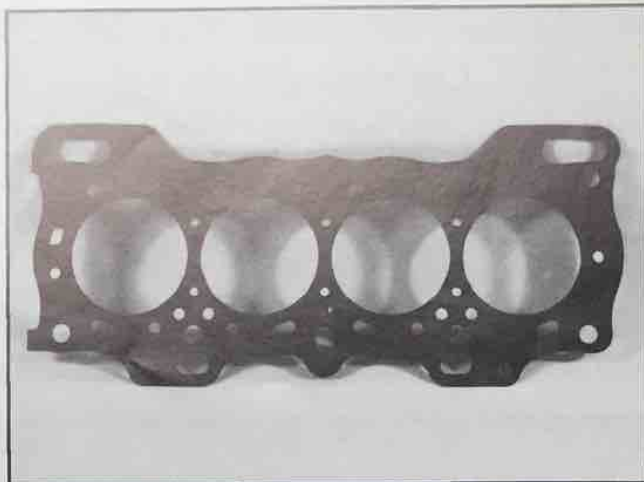

## 1600 DOHC Short Block (exploded view) 86-89 Integra

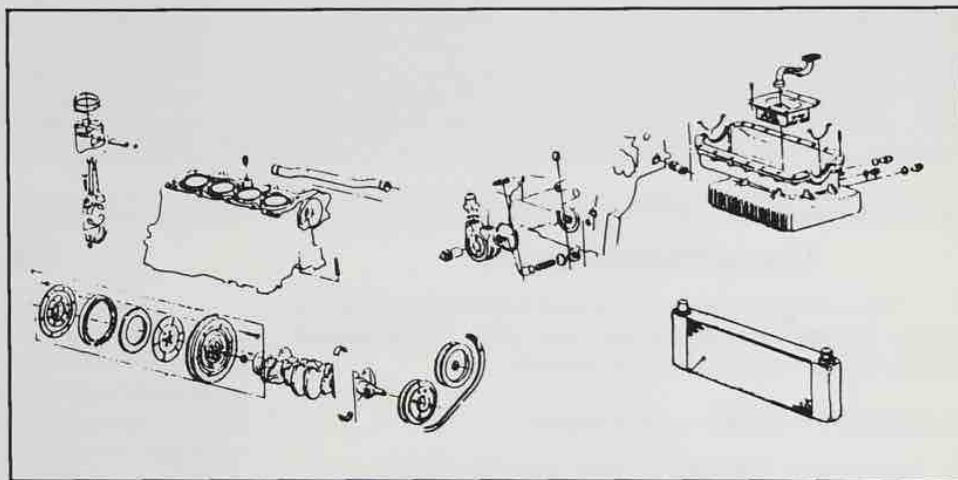

## Forged Piston Set

Mugen designed these Forged Pistons with the same technology as their Formula-One pistons. Because of the long stroke of the Integra engine, Mugen designed these pistons with very strong piston pin bosses to reduce the chance of failure. A single compression ring is used for weight and piston-drag reduction. These pistons have proven to be extremely reliable in use, with no failures. Superior materials & construction allow tighter piston-to-wall clearances than conventional forged piston sets. Comes Complete with pistons and rings.

75mm:13101-XB2-OORA 76mm:13101-XB3-OORA-B2

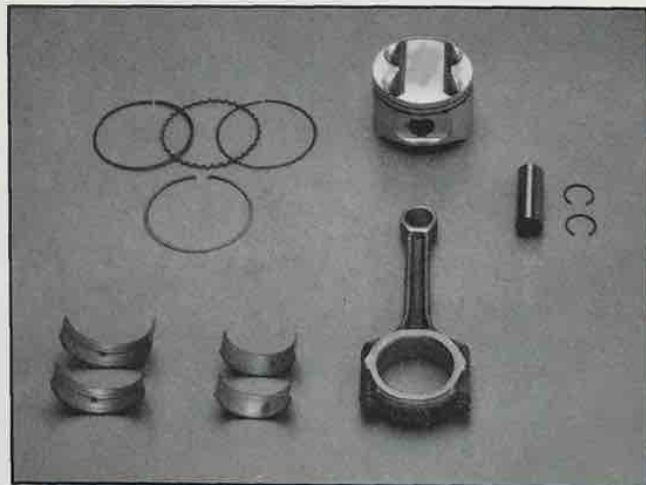

## Connecting Rods

Mugen prepares these rods for use in the Group A racers in Japan and the IMSA Acuras. Each rod is carefully magna-fluxed. The big ends are then machined to exacting tolerances and the small end is modified to use a full floating wrist pin. These rods have proven to be very durable.

13210-XB2-OORA

## Bearings

When used for racing and/or under high stress, the standard Honda bearings have proven to be inadequate. Mugen uses Clevite F-77 material for it's bearing construction, which is an industry standard. These bearings are extremely durable and will not scuff or flake like the standard bearings can. These bearings are a must for all racing applications.

see chart 6-1 for bearing part numbers and tolerances.

CHART 6-1

### Connecting Rod Bearing Sets - 8 Pieces

13211-XB2-SORA	"A" Blue T=1.5	(+0.013) (-0.010)
13212-XB2-SORA	"B" Black	(+0.010) (+0.007)
13213-XB2-SORA	"C" Brown	(+0.007) (+0.004)
13214-XB2-SORA	"D" Green	(+0.004) (+0.001)
13215-XB2-SORA	"E" Yellow	(+0.001) (-0.002)
13216-XB2-SORA	"F" Pink	(-0.002) (-0.005)
13217-XB2-SORA	"E" Red	(-0.005) (-0.008)

### Main Bearing Sets - 10 Pieces

13321-XB2-SORA	"A" Blue T=2.0	(+0.016) (+0.013)
13322-XB2-SORA	"B" Black	(+0.013) (+0.010)
13323-XB2-SORA	"C" Brown	(+0.010) (+0.007)
13324-XB2-SORA	"D" Green	(+0.007) (+0.004)
13325-XB2-SORA	"E" Yellow	(+0.004) (+0.001)
13326-XB2-SORA	"F" Pink	(+0.001) (-0.002)
13327-XB2-SORA	"E" Red	(-0.002) (-0.005)

## Compression Ratios

The following compression specs should be used as a guideline for determining compression ratios. Please double check by measuring the volumes yourself.

$$\text{COMPRESSION RATIO} = (V_c + V_s) / V_c$$

$V_c$  = Combustion Chamber Volume:  $V_c = V_H + V_g - V_p$

$V_s$  = Cylinder Volume:

$V_s(76) = 408.3\text{cc} - 76\text{mm Bore} \times 90\text{mm Stroke}$

$V_s(75) = 397.6\text{cc} - 75\text{mm Bore} \times 90\text{mm Stroke}$

$V_h$  = Head Volume

$V_h(1.5) = 38.6\text{cc} - 1.5\text{mm surfaced}$

$V_h(1.8) = 36.5\text{cc} - 1.8\text{mm surfaced}$

$V_h(2.0) = 35.5\text{cc} - 2.0\text{mm surfaced}$

$V_p$  = Piston Head Volume

(block should be decked 2.0mm)

$V_p(2.9) = 5.5\text{cc} - 2.9\text{mm Dome}$

$V_p(3.9) = 6.9\text{cc} - 3.9\text{mm Dome}$

$V_g$  = Head Gasket Volume

$V_g(76) = 5.6\text{cc} - 77\text{mm Gskt Bore } t = 1.2\text{mm}$

$V_g(75) = 5.3\text{cc} - 76\text{mm Gskt Bore } t = 1.2\text{mm}$

## Oil Supply System

As everyone knows, race engines require an excellent lubrication system. The oil supply system has a lot to say about the engine's durability. It takes a lot of testing and experience to develop a good system. By extensively testing engines on Mugen's dynamometer and on the racetrack we have developed a durable wet sump oil supply system.

1. Oil Pan. Made of cast aluminum, having high durability, a better cooling factor, strengthens engine block.
2. Baffle Plate. Separates oil from high speed turbulences in the crankcase. Under heavy force the plate keeps oil at the proper level for the oil pump.
3. Oil Strainer Nozzle. Original design for Mugen oil pan.
4. Pressure Control Spring. Raises pressure to specified level.
5. Oil Filter Base Plate. Designed as pick-up for external oil line, has internal relief valve.
6. Oil Cooler. Mugen designed a special oil cooler. It has a horizontal design, and is designed for summertime competition.
7. Oil Control Jet. This small part controls the important oil flow to the head and camshaft.
8. Main Bearings & Rod Bearings. These bearings are named F-77, which is used for high speed race engines. Mugen has several sizes for rebuilding.

Head Surfacing	Block Surfacing	Bore Size	Piston Dome Height	Compression Ratio
1.8	2.0	76	2.9	12.2:1
2.0	2.0	76	2.9	12.5:1
2.0	2.0	76	3.9	13.0:1
2.0	2.0	75	2.9	12.3:1





## Oil Pan Set

This Oil Pan Set was designed for Group A racing in Japan and has been used in all the IMSA Integras. This cast aluminum pan strengthens the engine block and its finned design allows for extra heat dissipation. Due to the unique design of its baffles and windage tray, this pan will give you an extra 5 horsepower. Oil capacity is increased to six quarts with the use of this oil pan.

11200-XB2-S7RA

## Oil Filter Spacer

This kit is required when using an external oil cooler (highly recommended for racing). It is equipped with an internal pressure relief valve and is designed to use the stock oil filter. This kit utilizes Aeroquip-12 fittings.

15400-XB2-SORA

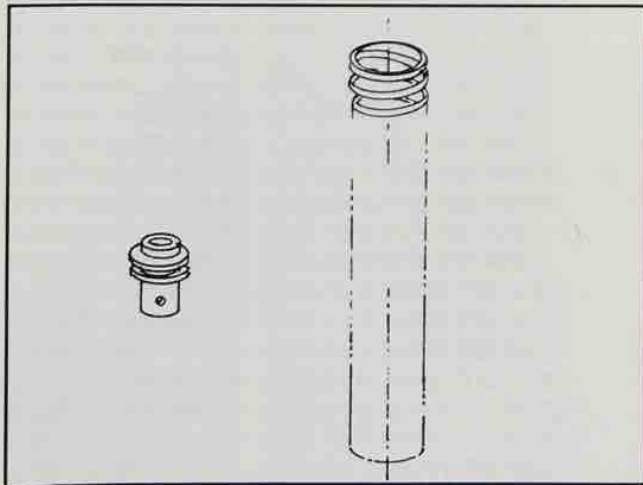
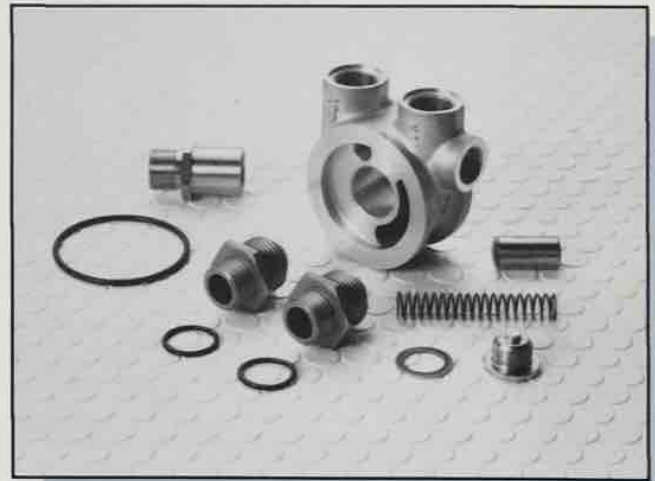

## Oil Control Jet & Relief Valve Spring

Maintaining the correct oil flow and pressure to the cylinder head requires the use of the Mugen Oil Control Jet and Relief Valve Spring.

JET: 15141-XB2-OORA SPRING: 15232-XB2-OORA

page 7

## 1600 DOHC Transaxle (exploded view)

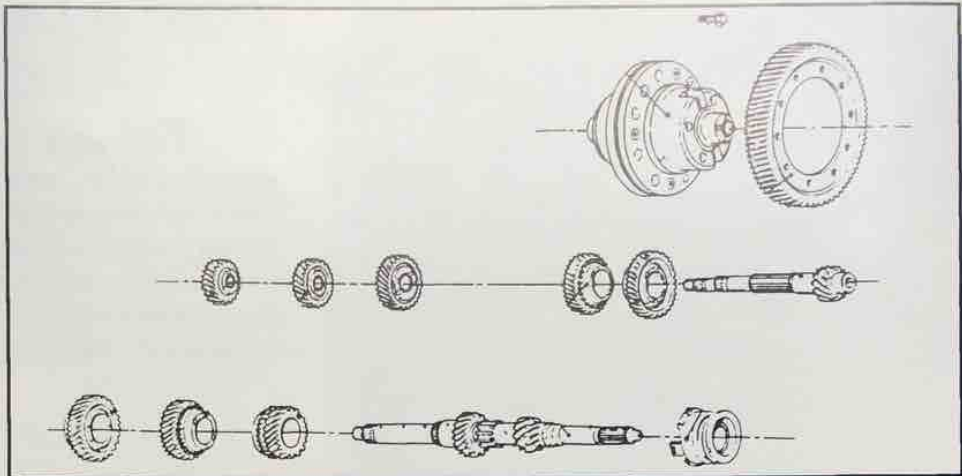

## Limited Slip Differential

Wheelspin when exiting a corner is very costly in terms of lap time. Mugen designed this Limited-Slip Differential to prevent wheelspin yet still be driveable. This unit has not shown any weakness in the past three racing seasons. Power can be applied much earlier in a corner.

86-89 Integra

41000-XB2-KOR

## Gearsets & Final Drives

Being able to keep your engine in its power band is critical in road racing. Part of the reason why Mugen race cars are so successful is their ability to stay in the power curve due to the vast amount of gear ratios Mugen has. Both in Japan and in the U.S. the performance of Mugen transaxle parts have been race proven again and again. Mugen uses helical cut gears to reduce driveline shock, and incorporates a heavy-duty syncro design. Third and fourth gearsets are made of a special material to reduce the chance of breakage.

- MAIN SHAFT SET A (2.250/1.650): 23210-XB3-SORS-A
- MAIN SHAFT SET B (2.053/1.590): 23210-XB3-SORS-B
- MAIN SHAFT SET C (1.900/1.590): 23210-XB3-SORS-C
- MAIN SHAFT SET D (2.053/1.789): 23210-XB3-SORS-D
- GEAR SET 3RD A (1.347): 23440-XB3-SORS-A
- GEAR SET 3RD B (1.304): 23440-XB3-SORS-B
- GEAR SET 3RD C (1.410): 23440-XB3-SORS-C
- GEAR SET 4TH A (1.103): 23450-XB3-SORA-A
- GEAR SET 4TH B (1.160): 23450-XB3-SORA-B
- GEAR SET 4TH C (1.208): 23450-XB3-SORA-C
- GEAR SET 4TH D (1.280): 23450-XB3-SORA-D
- GEAR SET 5TH A (0.967): 23460-XB3-SORS-A
- GEAR SET 5TH B (1.031): 23460-XB3-SORS-B
- GEAR SET 5TH C (1.042): 23460-XB3-SORS-C
- GEAR SET 5TH D (1.083): 23460-XB3-SORS-D
- GEAR SET 5TH E (1.103): 23460-XB3-SORS-E
- GEAR SET 5TH F (1.160): 23460-XB3-SORS-F
- GEAR SET FINAL A (4.071): 41200-XB2-SORA-A
- GEAR SET FINAL B (4.266): 41200-XB2-SORA-B
- GEAR SET FINAL C (4.461): 41200-XB2-SORA-C
- GEAR SET FINAL D (4.651): 41200-XB2-SORA-D
- GEAR SET FINAL E (3.800): 41200-XB3-SORS-E
- GEAR SET FINAL F (3.933): 41200-XB3-SORS-F
- GEAR SET FINAL G (4.000): 41200-XB3-SORS-G
- GEAR SET FINAL H (4.142): 41200-XB3-SORS-H
- GEAR SET FINAL I (4.384): 41200-XB3-SORS-I
- GEAR SET FINAL J (4.538): 41200-XB3-SORS-J

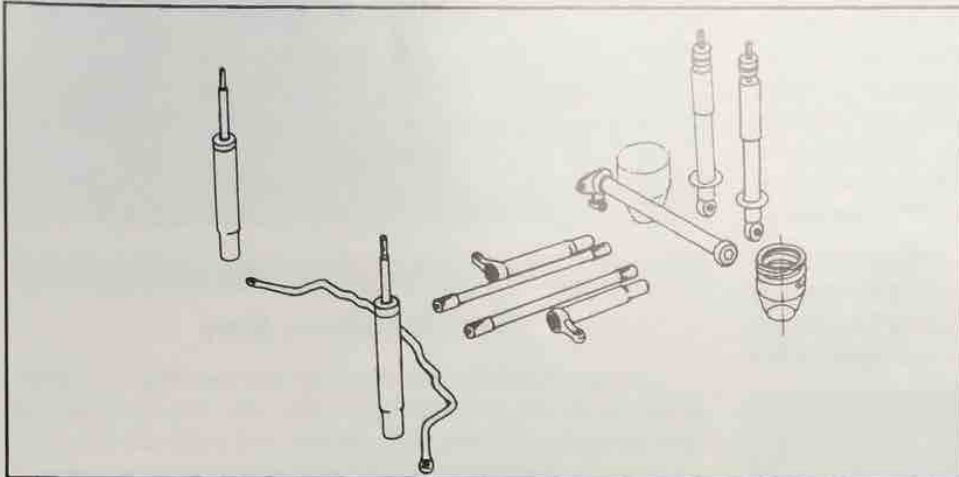

## Integra/ CRX/ Civic Suspension (exploded view)

**APPLICATION:**  
84-87 CRX/Civic  
86-89 Integra



### Group A Struts

These double adjustable racing struts were designed for Mugen's Group A racers in Japan, and have been used in the IMSA ProFormance cars in the U.S. with great results. Both rebound and compression settings can be changed separately to allow you to precisely calibrate the struts to track conditions. To prevent bottoming of the struts on lowered race cars, Mugen has made these struts shorter than standard for full suspension travel.

**51600-XB2-SORA**



### Front Stabilizer Bars

This stabilizer is a direct replacement of the factory stabilizer bar. It will not decrease ground clearance or break bushing mounts, which is common with aftermarket stabilizer bars. When installing this stabilizer bar, you must replace the factory stabilizer bushing set with the 21mm bushing set part number **51315-XB2-SOR**.

**21mm BAR: 51300-XB2-OORA-B4**

Available for road racing use only are larger 23mm and 25mm stabilizer bars. These front stabilizer bars also mount in the stock location, but because of the design of the arms your turning radius will decrease to an unacceptable level for street use.

**23mm BAR: 51300-XB2-OORA-B7**

**25mm BAR: 51300-XB2-OORA-B8**

### Torsion Bars & Torque Tubes

Instead of using a conventional spring in the front suspension, Honda chose to use a torsion bar arrangement.

*continued on page 10*

continued from page 9

This saves considerable space allowing for a lower hood profile on the CRX/Integra. Mugen manufactures special torsion bars for road-racing and autocross use where a stiffer spring rate is required. Mugen has also manufactured a special torque tube which further increases spring rate. Please remember when choosing a torsion bar set not to over stiffen the front of the car because this will actually deteriorate handling.

25.2mm TORSION BAR: 51400-XB2-SORA-A

25.6mm TORSION BAR: 51400-XB2-SORA-B

26.5mm TORSION BAR: 51400-XB2-SORA-C

SPECIAL TORQUE TUBE SET: 51400-XB2-OORA

## Wheel Rate Specs

### MUGEN:

Wheel Rate (kg/mm)	Torsion Bar	Torque Tube
4.96	26.5x570 C	Special
4.46	25.6x570 B	Special
4.22	25.2x570 A	Special
4.55	26.5x570 C	Standard
4.22	25.6x570 B	Standard
3.92	25.2x570 A	Standard

### STOCK:

Wheel Rate (kg/mm)	Torsion Bar	Model
1.44	18.6x621.6	CRX HF
1.74	19.7x621.6	CRX
1.76	20.9x651.6	Integra
1.95	20.1x611.9	Civic HB
2.08	20.6x611.9	Civic HB
2.14	20.7x629	Wagon 4WD

## Rear Springs

Mugen racing rear springs are designed to be used with the Mugen N-1 or Group A dampers. These rear springs have been used very successfully in the Group A cars in Japan and the IMSA Integras in the U.S. These springs cannot be used with stock dampers or the Mugen Sports Damper Kit because the spring height is too short.

(K=1.7 to 6 kg/mm): 52441-XB2-OORA-A

(K=1.9 to 7 kg/mm): 52441-XB2-OORA-B

(K=2.5 to 8 kg/mm): 52441-XB2-OORA-C

## Stock Rear Spring Specs

CRX	1.08 to 1.47 kg/mm	Integra	1.75 kg/mm
Civic	1.08 to 1.86 kg/mm	Civic Wagon	1.76 to 3.02 kg/mm

## Stock Stabilizer Bar Specs

FRONT:		REAR:	
Civic Wagon	20mm	CRX/Civic	15.5mm
Integra	19mm	Integra	17.0mm
Civic	18mm		
CRX	16mm		

## Rear Stabilizer Bars

The correct way to improve the handling of a front wheel drive car is to increase the rear roll stiffness. By increasing the rear roll stiffness you will eliminate the car's tendency to understeer. Mugen has designed these internal rear stabilizer bars to replace the factory stabilizer bar. Because of their design, these stabilizer bars will not rattle against the underside of your car or hit the muffler which is common with hang-on aftermarket stabilizer bars. King Motorsports recommends the 21mm bar for performance driving, and the 23 mm bar for autocrossing.

21mm BAR: 52300-XB2-OORA-B4

23mm BAR: 52300-XB2-OORA-B6

## Hard Bushing Kits

During road racing or autocrossing the stock rubber bushings will deflect causing a change in suspension geometry and loss of response. Mugen designed these bushings with a high durometer rated rubber to enhance response and lessen the chance of deflection. Because these bushings were made using O.E.M. molds, you can be assured of exact fit for each application.

PANHARD ROD BUSHING SET: 52360-XB2-SOR

TRAILING ARM BUSHING SET: 50209-XB2-SOR

REAR SPRING UPPER SEAT RUBBER: 52691-XB2-SOR

FRONT STABILIZER BAR BUSHING SET: 51315-XB2-SOR

FRONT STABILIZER RUBBER SET: 51312-XB2-SOR

STEERING BOX CUSHION SET: 53434-XB2-SOR

RADIUS ARM BUSHING SET: 51396-XB2-SOR

REAR STABILIZER RUBBER SET: 52314-XB2-SOR

MOUNT COMPLETE, FRONT DAMPER: 51920-XA1-083

LOWER FRONT ARM SET: 51301-XB2-SOR

NOTE: The first number of the spring rate represents spring rate at static ride height. The second number represents the spring rate at 2 inches of compression.

## N-1 Struts

A less expensive alternative to the Group A struts are the Mugen N-1 Struts. While these units are non-adjustable, they still offer a great performance advantage over regular heavy-duty struts. The N-1 struts are also shorter than stock, but should not be considered for street use because they are very stiff. If you are contemplating building a CRX for SCCA ITB Racing, these struts will give you the competitive edge over all after-market struts.

51600-XB2-SORN-B2

## Camber Shims & Toe Plates

The rear suspension of the CRX/Civic and Integra has no provision for adjustment of alignment. In some circumstances, such as road racing and autocrossing, adjusting the rear alignment can result in great benefits. Mugen manufactures these shims & plates from stainless steel to allow for some adjustment. These pieces are easy to install and require no modification to the rear suspension.

**TOE PLATE TOE 0.0 DEGREES: 52379-XB2-OORA-B**

**TOE PLATE TOE OUT 0.25 DEGREES: 52379-XB2-OORA-B2**

**CAMBER SHIM -0.3 DEGREES: 92121-XB2-OORA-A**

**CAMBER SHIM -0.5 DEGREES: 92121-XB2-OORA-B**



## Hard Rubber Engine Mount Kit

Hard acceleration and deceleration will cause the stock engine mounts to flex, allowing the engine to rock back and forth. Mugen designed these mounts to stabilize the engine for road racing, autocrossing, or high horsepower use. O.E.M. molds are used for an exact fit.

**SIDE ENGINE MOUNT: 50820-XA1-OOR**

**FRONT ENGINE MOUNT: 50805-XB2-OOR**

**REAR ENGINE MOUNT: 50810-XA1-OOR**

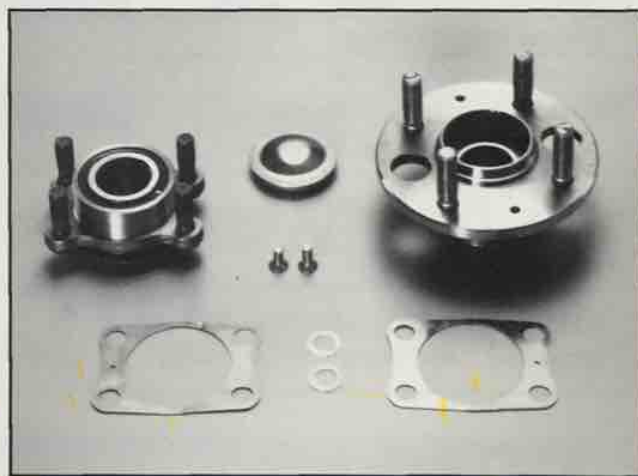

## SS100 Brake Pads

In Showroom Stock endurance racing it is critical to reduce the number of pit stops necessary. Stock or aftermarket brake pads can fail in hard racing situations. The Mugen SS100 Brake Pads use a hard compound pad material that will out-live all other pads. Because of the hard compound material, this pad should only be used for road-racing and not street or autocross.

CRX (84-87): 45000-XA1-KOS

Integra/CRX/Civic Suspension Tech Sheet	PERFORMANCE DRIVING	PERFORMANCE & AUTOCROSS	SERIOUS AUTOCROSS	AUTOCROSS MODIFIED
Mugen Shocks				
Mugen 14x6 Wheels				
21mm Front Stabilizer Bar				
21mm Rear Stabilizer Bar				
23mm Rear Stabilizer Bar				
Front Engine Mount				
Rear Engine Mount				
Side Engine Mount				
Panhard Rod Bushing				
Trailing Arm Bushing				
Rear Upper Spring Seat				
Rear Stabilizer Rubber				
Steering Box Cushion <i>DISC.</i>				
Radius Arm Bushing				
Lower Front Arm Set				
Front Stabilizer Bar Bushing				
Front Stabilizer Bar Rubber				
25.2 Torsion Arm				
N-1 Shock Set				
Mugen Rear Springs				
<b>RECOMMENDED CHASSIS SETTINGS:</b>				
1mm Toe Out Front; 0 Toe Rear; 1 Degree Neg Camber Front; 1/2 Degree Neg Camber Rear.				

## CRX In SCCA ITB Racing

KMS is very excited about the results of our IT development program. Many components have been tested and re-tested. We feel we have developed the right combinations for horsepower, reliability and handling. This car has proven to be faster than any ITB cars in the Central Division. For more information please call King Motorsports.

The following are the kits we have developed. It is important to note that all modifications done to our car can be done by the average enthusiast. No need for elaborate tools or technology!



**STAGE I SUSPENSION:** Tokico Illumina Struts, Complete Mugen Hard Rubber Bushing Kit, 15mm front and 23mm rear Stabilizer Bars, Sport Rear Spring Kit, Specially prepared Torsion Bars, Mugen Hard Rubber Engine Mount Kit, and Mugen 13x5.5 CF48 Wheels.

**STAGE II ENGINE:** Mugen Header, Mugen Flex Joint, KMS IT Exhaust, 34/34 Weber Conversion, Recurved Distributor, Ultra Ignition Wires.

## Mugen Performance Accessories

### Exhaust Manifolds

The very first step in increasing engine performance should be in your exhaust system. This will produce the most horsepower per dollar and become the basis for all further engine development. Mugen has chosen a Tri-Y design for their exhaust manifold after considerable development and dyno time. Although it is true a 4 into 1 design will produce more ultimate horsepower, this only happens at very high RPM and is suitable for racing purposes only. A Tri-Y design will consistently produce more power throughout a **broader** RPM band than any 4 into 1 design. The reason that most manufacturers use the 4 onto 1 design is because they are very inexpensive to produce. All Mugen exhaust manifolds use TIG/Gas welds which are superior in strength and finish to other products on the market. Also, instead of a cold bending process which produces a tubing size reduction, Mugen uses a costly sand bending method for absolutely uniform tube dimensions. All Mugen exhaust manifolds come complete with O.E.M. gaskets and mounting hardware for long lasting trouble-free performance.

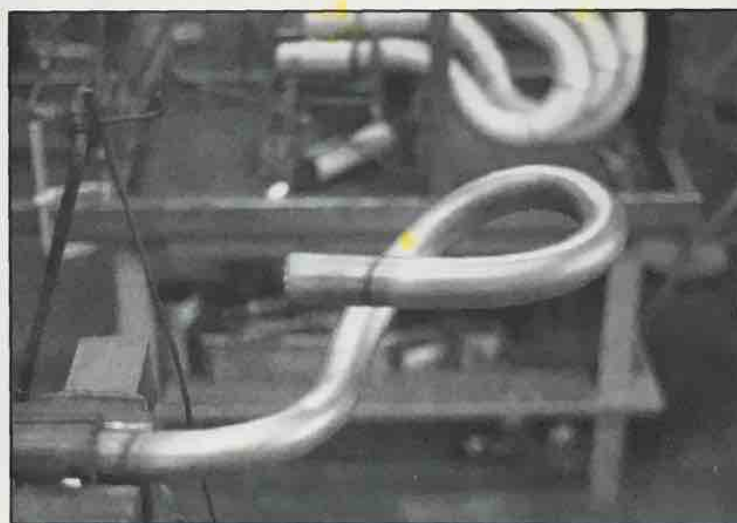

**TOP RIGHT:**

*A Mugen technician demonstrates the sand bending technique used on all Mugen exhaust manifolds.*

**RIGHT:**

*An example of a sharp-angle bend without any tubing size reduction.*



CRX/CIVIC



83-87 PRELUDE 1.8 litre



86-87 INTEGRA

## Exhaust Pipes & Silencers

To complete a Mugen exhaust system, a Mugen silencer set is a necessity. All Mugen silencer sets are designed as direct O.E.M. replacements, therefore all existing mounting locations are used for easy installation. Each silencer set is constructed with aluminized steel coated with a tough, baked-on heat resistant paint to protect against corrosion. Sound quality is enhanced to a deep throaty tone that does not detract from the overall quietness of your car. All necessary O.E.M. mounting hardware is included along with comprehensive assembly instructions.

*RIGHT: Integra Silencer*  
*BELOW LEFT: CRX Silencer Set*  
*BELOW RIGHT: 84-87 Prelude Silencer Set*

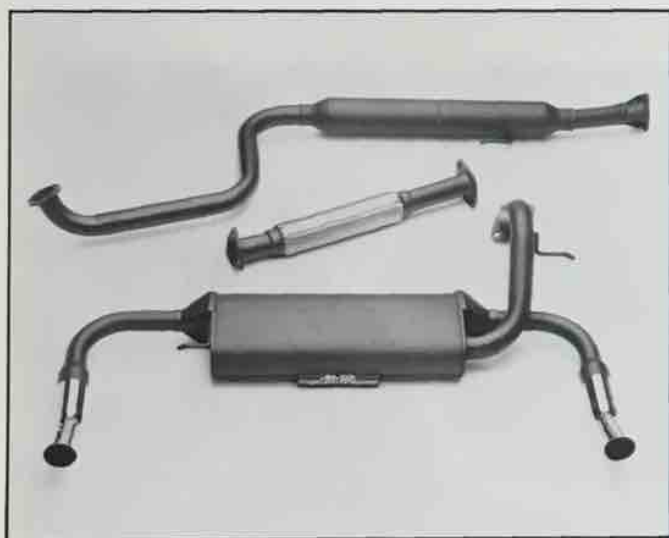

	EXHAUST MANIFOLD	FLEX JOINT	EXHAUST PIPE	SILENCER
84-87 CRX 1.5 litre w/carb	18200-XA2-K84	18300-XA2-084	incl w/silencer	18100-XA1-084
85-87 CRX HF 84 1.3 litre	18200-XA2-K84	18300-XA2-084	incl w/silencer	18100-XA1-084
85 CRX SI	18200-XA1-K84	18300-XA1-084	incl w/silencer	18100-XA1-K84
86-87 CRX SI	18200-XA1-K84	18300-XA2-084	18220-XA1-OOS	18307-XB1-S1S
84-87 Civic HB w/carb	18200-XA2-K84	18300-XA2-084	18220-XA1-OOS	18307-XA1-SOS
86-87 Civic Si HB	18200-XA1-K84	18300-XA1-084	18220-XB2-003	18307-XA1-SOS
86-87 Integra 3 Door	18100-XB3-KOS	incl w/manifold	18223-XB3-OOS	18307-XB3-SOS
86-87 Integra 5 Door	18100-XB3-KOS	incl w/manifold	18225-XB3-OOS	18307-XB3-SOS



## XA1 Camshaft

This camshaft was designed primarily for performance driving, therefore it does not have any flat spots or power peaks. Instead, you can expect a very broad power band with the engine pulling strongly all the way to 8000 RPM. Because this is a **billet** camshaft, you retain correct rocker arm geometry which is a common problem with reground camshafts. Maintaining this geometry results in a quieter running camshaft which stays in adjustment longer than a regrind. Unique to this camshaft is its Chrome-face plating which is superior to all other heat-treating hardening processes. Available for 84-87 CRX/Civic w/carb.

14110-XA1-OOS

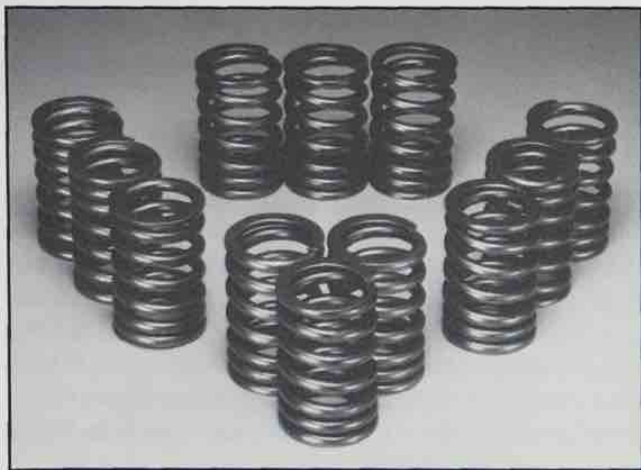

## Mugen Valve Spring Kit

The use of a high-lift camshaft such as the Mugen XA-1 dictates the use of a Mugen Valve Spring Kit. The combination of a high-lift cam and high RPM use can cause the stock springs to float or oscillate resulting in loss of horsepower and potential damage to the valvetrain. The Mugen Valve Spring Kit will eliminate these potential problems, giving you a trouble-free, reliable valvetrain. Available for 84-87 CRX/Civic.

14760-XA1-K83

## Polished Valve Set

Mugen uses stock O.E.M. valves with great confidence in their own race engines. These valves, although, have received the "Mugen Touch". Each valve is lightened and highly polished to increase intake and exhaust flow, while maintaining the longevity and reliability of the standard steel valves. Available for 84-87 CRX/Civic.

14110-XA1-OOS



page 15

## Integra Big Bore Piston Kits

This piston kit was designed as a relatively inexpensive way to increase both the horsepower *and* torque of the Integra engine. Mugen designed this kit using it's considerable Group A and IMSA experience to produce a complete system that is not only durable for performance driving, but produces a great deal of power. The rods and wrist pins are modified stock units, and the pistons are constructed with similar design to Mugen's IMSA pistons, utilizing highly supported wrist pin bosses. For best results, this kit should be used with a Mugen exhaust and Mugen intake manifold.

The Mugen Big Bore Piston Kit includes:

**Pistons:** Die-Cast Aluminum, 2 compression rings, 1 oil ring, 76.5mm diameter (1.5mm oversize), 10.0-10.7-to-1 compression ratio, full-floating wrist pin, valve recession for 10/40 Mugen Sport Cams; **Connecting Rods:** Modified Stock units, full-floating small ends; **Gasket:** Special Mugen oversize gasket. **13100-XB3-KOSJ**  
86-89 Acura Integra.

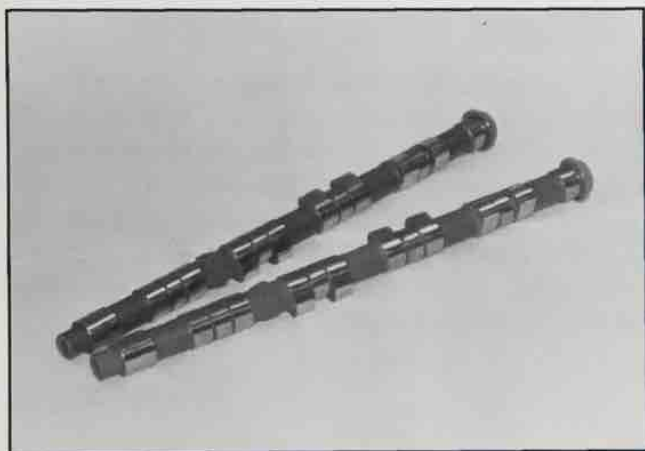

## Integra Sport Camshaft Set

The overall goal in the design of the Mugen Sport Camshaft set was to increase horsepower throughout the entire RPM range. Mugen not only met that criteria, but exceeded it. Useable horsepower starts at 2000 RPM and continues strongly to 8000 RPM. When used with the Big Bore Piston Kit there is a great deal of low-end torque with spectacular top end punch. As with all Mugen camshafts this Sport Camshaft Set is made from cast billets to retain stock rocker arm geometry.

86-89 Integra

**14100-XB3-KOSJ**

## Head Gasket CRX/Civic

Mugen designed this head gasket for racing or high performance applications where the stock head gasket was found to be inadequate. Carbon graphite was used to provide superior sealing capabilities. Mugen also made this head gasket thinner (1.0mm) as compared to the stock unit's 1.2mm thickness. This variation raises the compression by 0.2. Increased reliability under race conditions and Mugen's high quality standards make this Head Gasket a must for your competition needs.

84-87 CRX/Civic 1500

**12251-XA1-084**

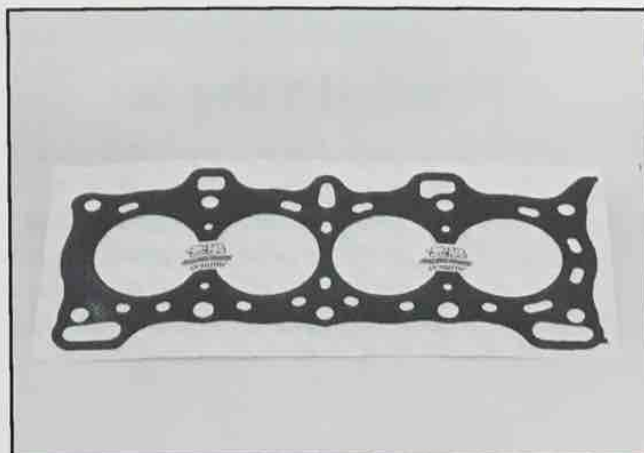



## Limited Slip Differential

For Autocrossing or performance driving where inside wheelspin is a problem, a Mugen Limited Slip is essential.

Wheelspin will be eliminated with the use of this unit. Because of its design the Mugen Limited Slip will not jerk the steering wheel or cause drivability problems.

84-87 CRX/Civic

14760-XA1-K83

## Integra Clutch

For performance driving and high horsepower applications the Mugen Integra Clutch is a must. Mugen has designed this clutch with a very high clamping force compared to the stock unit. This will reduce the chance of slippage during high stress periods. These clutch units are entirely streetable and do not have a high clutch pedal effort. Comes complete with clutch cover and clutch disc.

86-89 Integra

22300-XB2-OORN

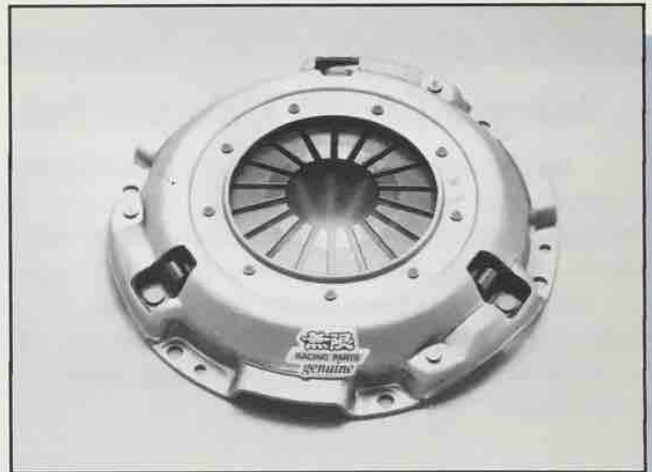

## Mugen CF-48 Wheels

Unique in style and design, Mugen's one piece cast aluminum wheels use a fan cowl design to help direct air where it's most needed - your brakes. If you prefer the looks without the cowl, simply remove four small bolts with the tool provided. All Mugen wheels are hub-centric and have the *correct* offset for optimum handling and reliable performance. Also, because of their unique design and construction, Mugen wheels are among the lightest and strongest wheels available. Bolt pattern is 4 x 100mm.

SILVER 13X5.5: 42000-CF3-55S

WHITE CHROME CUT 14x6: 42700-CF48-1460CW

GUN METAL CHROME CUT 14x6: 42700-CF48-1460GM

WHITE CHROME CUT 15x6: 42700-CF48-1560CW

GUNMETAL CHROME CUT 15x6: 42700-CF48-1560-GM

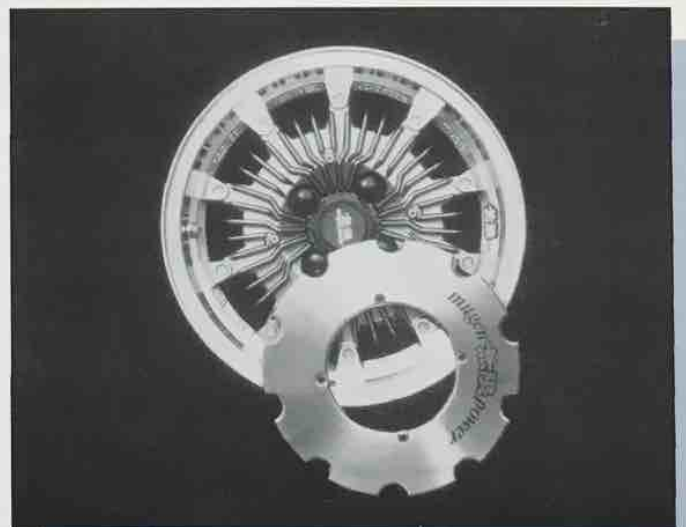

page 17



## Sports Damper Set

As in the past, Mugen has teamed up with Showa in the design and production of their Sports Damper Sets. Although "gas" struts are the new marketing tool in the industry, both Mugen & Showa felt a hydraulic damper was best able to meet their stringent standards, producing very precise bump and rebound settings. Included with each Sports Damper kit are Mugen hard rubber bushing damper mounts. The Mugen Sports Damper kits are legal in all stock class autocross as well as street prepared and IMSA and SCCA professional showroom stock racing.

84-87 CRX/Civic

50000-XA1-K83

## Integra Sports Damper Set

Specifically designed jointly between Showa and Mugen for the Integra. Unlike most aftermarket shock manufacturers which use CRX dampers for Integra applications. Although CRX dampers will fit the Integra, the car's weight and balance make the CRX shock valving ineffective. This damper set will eliminate the "floaty" feel of the stock dampers with becoming harsh.

86-89 Integra

50000-XB3-KOS



## Prelude Hard Suspension Kit

As with their CRX Sports Damper Kit, Mugen chose Showa to help design and manufacture it's Prelude Hard Suspension Kit. Mugen uses hydraulic struts so they can precisely calibrate rebound and compression settings. Mugen has also changed spring rates to stiffer in the front and slightly softer in the rear. The resulting ride quality is not harsh or jarring, but very controlled with no pitching and rolling. Kit comes assembled with Mugen hard rubber spring mounts.

83-87<sup>1/2</sup> Prelude

50000-XAO-KOS



## SUSPENSION DAMPENING SPECS

		FRONT		REAR	
		Standard	Mugen	Standard	Mugen
<b>PRELUDE:</b>					
Dampening Force	Rebound	70	120	35	50
0.1/sec/kg	Compression	22	85	16	25
Dampening Force	Rebound	130	170	60	80
0.3m/sec/kg	Compression	45	120	25	35
Spring Rate teg/mm		5.4	6.21	2.36	2.17
<b>CRX/CIVIC:</b>					
Damping Force	Rebound	33	75	25	50
0.1m/Sec/Kg	Compression	15	50	15	20
Damping Force	Rebound	60	110	65	80
0.3m/Sec/Kg	Compression	25	70	25	30

## Mugen Rear Spoilers

While other rear spoilers are designed to look pretty, Mugen spoilers are designed to work and be attractive at the same time. Mugen spoilers do not require any drilling before mounting, but use a unique clip system that will not mar your car's finish and is very secure. All Mugen rear spoilers are constructed of hard rubber and can be painted to match the color of your car.

*(below left) CRX : 84110-XA1-83W (below right) CIVIC: 84112-XA2-KOB (bottom left) PRELUDE: 84112-XA0-KIB (bottom right) INTEGRA: red-84112-XB3-KOB-R white-84112-XB3-KOB-W black-84112-XB3-KIB*





After many years of racing Honda Products exclusively, it is my desire to offer you the same championship winning parts that have helped me win races. Our company is dedicated to producing and marketing only the very finest products which have been proven under the most grueling conditions. We are very proud to be designated an 'Authorized U.S. Distributor' for Mugen Co., Ltd. You can expect only the highest quality products from Mugen. We work very closely with Mugen and in the upcoming months you will see some very exciting new product releases. It is my personal commitment to you that King Motorsports will strive to provide you with the best products for winning results.



Jim Dentici, President





## Mugen Body Kits

Mugen has spent considerable time and effort to produce what we feel is the finest body kit on the market. Mugen's fiberglass fit and finish is unparalleled in the industry. What this means to you is a kit that fits right the *first* time without the usual problems associated with body kits in general. Included with each kit are extensive assembly instructions, and all O.E.M. mounting hardware.

(left) CRX BODY KIT

(below left) CIVIC BODY KIT

(below right) INTEGRA BODY KIT



## Accord Front Air Dam

Mugen designed this Air Dam to enhance the clean, encluttered lines of the Accord and to decrease aerodynamic drag. This one-piece fiberglass air dam is designed to fit over the stock bumper and requires no hole cutting or drilling. This spoiler was also designed to accept the factory fog lamp kit. Combined with the Mugen rear spoiler your Accord will stand out from the crowd!

62511-XB4-KOSJ-B2





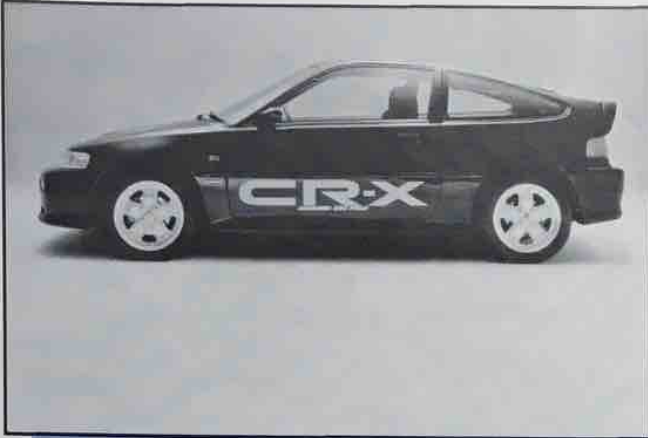

## 1988/89 CRX/Civic Performance Accessories

### Hard Rubber Suspension Bushings

As they did with the first generation CRX/Civic suspensions, Mugen has developed a full line of Hard Rubber Suspension Bushings for the 88/89 CRX/Civic. Because Mugen uses the factory molds for all their bushing kits you can expect precise fit. These bushing kits will minimize any bushing deflection under all conditions. These bushings should be considered mandatory for Autocross and Showroom Stock endurance racing.



#### HARD RUBBER BUSHING FIT LIST

Engine Mount Kit	50800-XE5-SONO
Front Upper Arm Set	51455-XE5-SONO
Front Lower Arm Set	51393-XE5-SONO
Front Radius Rod Set	51395-XE5-SONO
Front Shock Absorber Fork Set	51810-XE5-SONO
Front Stabilizer Set	52316-XE5-SONO
Rear Stabilizer Link Set	52314-XE5-SONO
Compensator Arm Set	52343-XE5-SONO
Rear Lower Arm Set	52365-XE5-SONO
Rear Trailing Arm Set	52385-XE5-SONO
Rear Upper Arm Inner Bushing Set	52393-XE5-SONO
Rear Upper Arm Outer Bushing Set	52395-XE5-SONO
Steering Box Cushion Set	53434-XE5-SONO
Rear Shock Absorber Mount Set	51631-XE5-SONO
Front Spring Mount Set	51686-XE5-SONO
Rear Spring Mount Set	62686-XE5-SONO
Front Stabilizer Set (18mm)	51316-XE5-SONO-B1

### Hard Rubber Engine Mount Kit

The new generation CRX/Civic can be quite hard to drive smoothly in first and second gear. This is because the stock engine mounts allow the engine to move, causing driveline "snap". This is particularly pronounced in the Si models. Mugen produces these mounts for performance driving, such as Autocrossing and Road Racing where this situation can become a problem. These engine mounts are made using the original molds for exact fit.

## Stabilizer Bars

One of the easiest and most cost-effective ways to enhance the handling of your 88/89 CRX/Civic is to change the standard stabilizer bars. Mugen has perfected these stabilizer bars in the N-1 race series in Japan. These stabilizer bars mount directly to your existing mounting hardware and require **no** drilling. They are also made with the same material and methods that your standard stabilizers are constructed of. KMS recommends using these bars in pairs. The 20mm rear stabilizer is recommended for performance driving and the 22mm rear stabilizer is perfect for Autocrossing or endurance racing. Cars not equipped with a factory rear stabilizer require the use of a KMS mounting kit.

20mm FRONT: 51300-XE5-SONO-B2

20mm REAR: 42300-XE5-SONO-B2

22mm REAR: 52300-XE5-SONO-B1

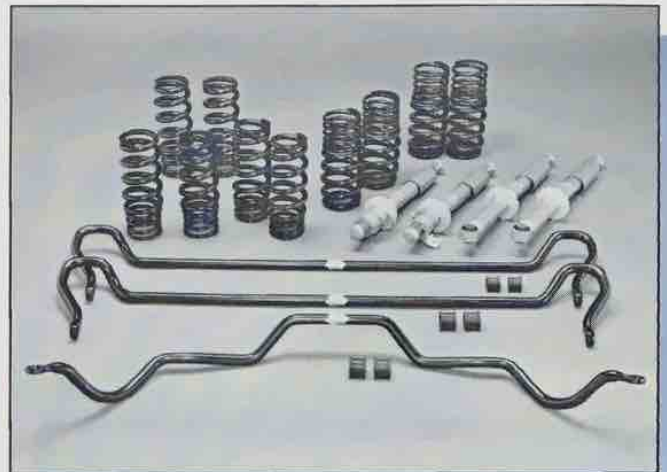

## Sports Damper Kit

As with all of their damper kits, Mugen joined forces with Showa in the design and construction of the Sports Damper Kit for the 88/89 CRX/Civic. Mugen has put considerable effort in developing a damper kit that would compliment the handling of the new generation CRX/Civic without destroying its ride quality. You will immediately notice a taut yet supple ride without the wallowing and uneasy feeling the stock dampers give during performance driving. Each Sports Damper Kit is pre-assembled with matched Mugen Springs and Mugen Hard Rubber Bushings. There is no need for spring compressors when installing this kit. Typical installation time is 2 hours.

88/89 CRX/Civic: 5000-XE4-KOSJ

### SPORTS DAMPER KIT SPECS

	FRONT	REAR
Overall Dampening	40% Stiffer	20% Stiffer
Overall Spring Rate	29% Stiffer	12% Stiffer



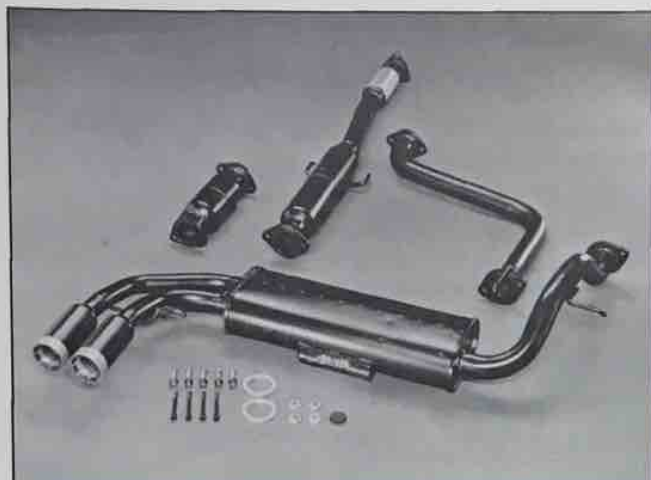

## Sport Exhaust System

Constructed with the same expertise and care as the rest of the Mugen exhaust line up, this Sport Exhaust System is the first step to higher engine performance. This system mounts to all the stock hangers to assure you of rattle and resonance free performance. Also included are O.E.M. gaskets and hardware for trouble-free installation. This system produces a deep mellow note without the raspiness common to aftermarket systems. Because this is a Mugen exhaust system, you are assured of the utmost in performance and longevity.

88/89 CRX: 18000-XE4-KOSJ  
88/89 Civic: 18000-XE5-KOSJ

## 88/89 CRX/Civic Clutch

For performance driving or Autocrossing a Mugen clutch should be considered mandatory. While the stock clutch is adequate for everyday use, high horsepower and high stress use can cause failure. The Mugen clutch for the CRX/Civic will lessen this chance of failure. This unit is entirely streetable and does not cause high clutch pedal effort.

88/89 CRX/Civic: 22300-XE5-OONO

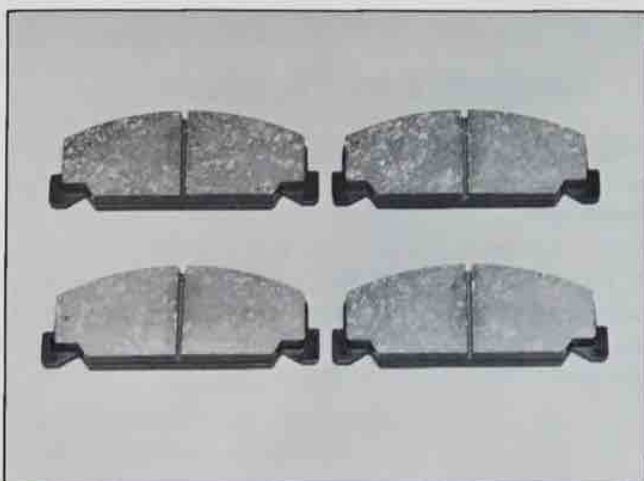

## SS100 Brake Pads

For endurance racing, brake performance and longevity can in many cases be a determining factor in winning. Mugen has prepared these brake pads to provide the utmost in stopping power and have long life. Unlike full metal type brake pads, Mugen SS100 brake pads are very easy on brake rotors. Unnecessary pit stops to replace brake pads and rotors can be avoided with the Mugen SS100 Brake Pads. Not recommended for street use.

88/89 CRX/Civic: 45022-XE5-KONO



## Mugen MR-5 Wheels

Spectacular styling and uncompromising quality are the key phrases used in describing the new Mugen MR-5 Wheel. This 3-piece modular wheel combines low temperature, low pressure die cast Aluminum rims with forged Aluminum centers for an extremely strong, yet incredibly light weight package. As with all Mugen wheels, the MR-5 wheel is hub-centric and has the correct offset for all Honda/Acura applications.

RIM SIZE	14x6	15x6	---16 x6.5---	
OFFSET	38	38	38	38
BOLT PATTERN	4x100	4x100	4x100	4x100
COLOR	Silver	Silver	Silver	Silver
WEIGHT	12.32	12.32	15.18	15.18

## 88/89 CRX Rear Spoiler

Add the "Mugen Touch" to the appearance of your 88/89 CRX with this Mugen Rear Spoiler. While its looks are stunning, Mugen designed this spoiler to be functional as well! This spoiler does not detract from rearward vision and the third brake light is also unobstructed. Installation is very easy with complete hardware included. All Mugen 88/89 CRX Rear Spoilers are color-matched to your CRX using the original Honda color codes. Available colors are: Black, Red, Yellow, and White.

*Black:* 84112-XE4-KOSO-BL

*Red:* 84112-XE4-KOSO-R

*Yellow:* 84112-XE4-KOSO-Y

*White:* 84112-XE4-KOSO-W



## Mugen Key Holders

While it's doubtful these attractive key holders will give you more performance, they are a most unique addition for the total "Mugen Driver". The Mugen Group A Civic Keyholder is a colorful replica of the All-Conquering Mugen Group A Civic. The Formula 3 and Formula 3000 Keyholders are minute metal reproductions of the championship-winning Mugen race engines finished in satin silver. These keyholders are very durable and a sure conversation piece wherever you go!

*Group A Civic:* 90000-YZ7-0001

*F3 Engine:* 90000-YZ7-0002

*F3000 Engine:* 90000-YZ7-0003

## Mugen Steering Wheel

If the most direct link between a driver and his/her car is the steering wheel, a Mugen Steering Wheel can change your whole driving experience. This handsome 13.5" steering wheel looks as great as it feels! Constructed from black anodized aluminum and bound in rich black leather for a sure and comfortable grip, the Mugen steering wheel should be mandatory for any serious Honda/Acura aficionado. Included with each kit is the "Mugen Power" horn button. Also available is a matching leather-bound horn pad cover embossed with the "Mugen Power" logo.

STEERING WHEEL: 53110-SW1-K84

ADAPTER: 53130-SW1-K84

LEATHER HORN PAD: 53120-SW1-K84



Fits all Honda/Acura applications



4. MUGEN POWER DIE CUT DECALS

## Decals & Emblems

Now that your car is equipped with the best, let everyone know you are driven by "Mugen Power." All decals are made from the highest quality transfer material. Emblems are self-adhesive, allowing for permanent attachment.

DECAL, LARGE WHITE: MD-0001-LRG-WHT

DECAL, LARGE BLACK: MD-0002-LRG BLK

DECAL, SMALL WHITE: MD-0003-SML WHT

DECAL, SMALL BLACK: MD-0004-SMLBLK

CRX FRONT WINDOW DECAL: MD-0005-WNDW

SMALL GOLD EMBLEM: 90000-Y28-SIG

SMALL SILVER EMBLEM: 90000-Y28-SIS

SMALL RED EMBLEM: 90000-Y28-SIR

LARGE GOLD EMBLEM: 90000-Y28-LIG

LARGE SILVER EMBLEM: 90000-Y28-LIS

LARGE RED EMBLEM: 90000-Y28-LIR

## Interlock Shirts & Lightweight Jackets

Attractive "Mugen Power" sportswear with contemporary styling. The Lightweight Racing Jackets feature a light poly fill to keep out the morning chill, yet are comfortable enough for all around use. The Interlock Shirts are made from 50/50 poly-cotton blend and look great at the track or other leisure time activities. Best of all both come embroidered with the "Mugen Power" emblem so everyone knows you're a formidable competitor.

specify size on order sheet

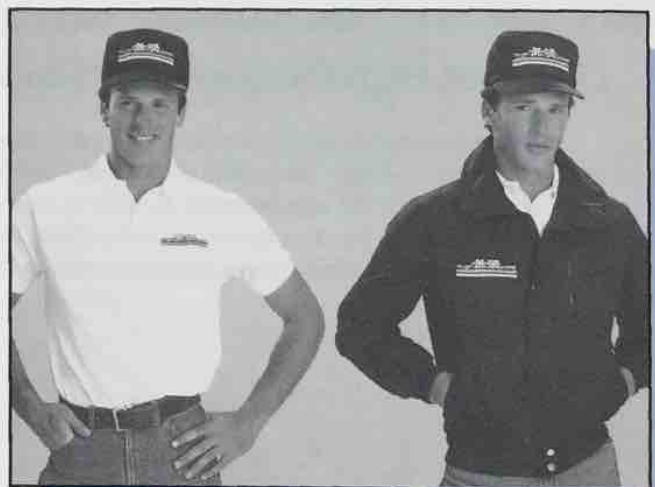

## Forged Racing Pistons

The design of a racing piston is one of the most complex aspects of a racing engine. KMS has spent literally hundreds of hours on the design of our forged pistons. Many dome shape configurations have been tested in order to get the ultimate flame travel. The result of all this work are pistons that produce the most horsepower on our dyno and have proven durable in our race cars. All pistons are full floating and come complete with rings and wrist pin clips. Available for: Civic 1200 EB1, EB2, EB3; CRX 1.5 litre, Integra, and Prelude.

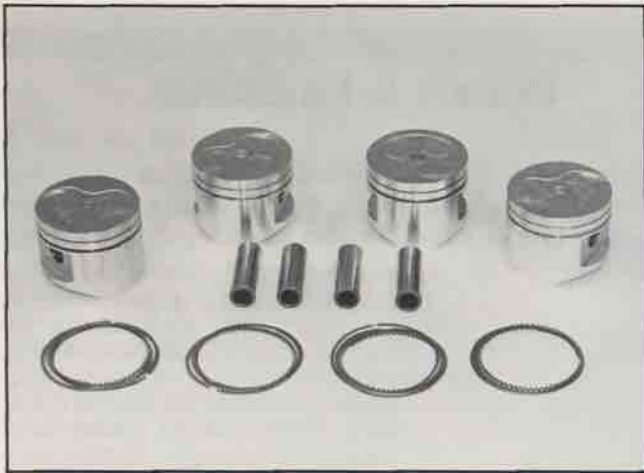

## CRX High Compression Pistons (1.5 litre)

By raising the compression of the 1.5 litre CRX engine you will noticeably improve horsepower throughout the entire RPM range. These cast pistons use only one compression ring to lessen piston drag. These pistons are suitable for all performance work and are extremely reliable. With a standard CVCC cylinder head the compression ratio is 10.2 to 1 and Si heads will have 10.0 to 1 compression.

## Civic 1200 High Compression Pistons

For performance driving and autocrossing this piston kit is an inexpensive way to boost the power of the Civic 1200. When used with an EB-2 head, the compression ratio is 11.0 to 1 and an EB-3 head will have 10.0 to 1 compression ratio. These pistons are available in 72mm and 73mm bores and come complete with rings.

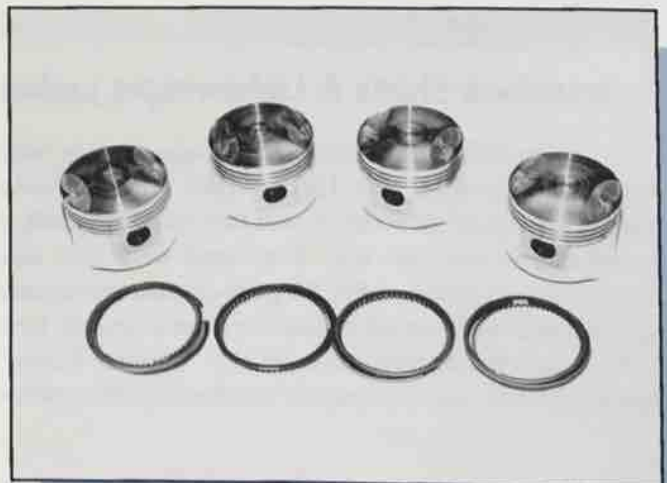

## Valve Train

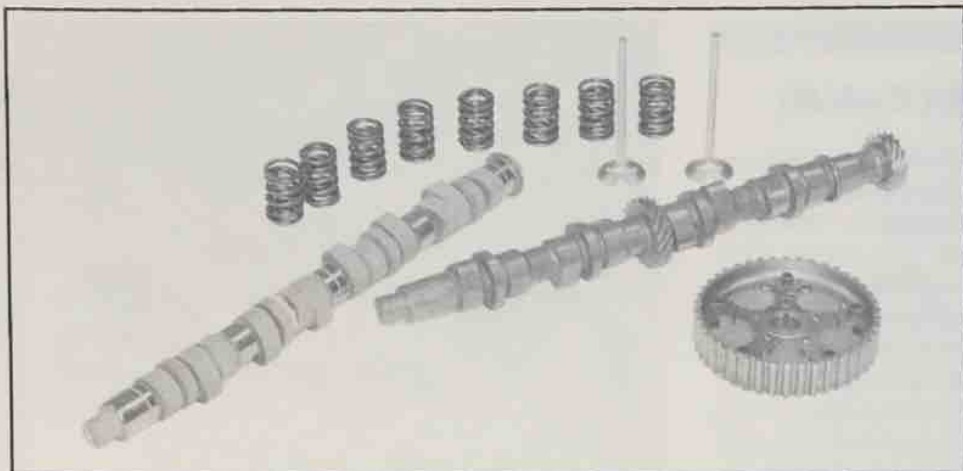

### 85-87 CRX/Civic Si Camshaft

Finally, after much research, dyno work, and road testing, KMS has developed a camshaft for the Si that **really** works. Previously, Si camshafts on the market basically changed your powerband, some all high RPM with very bad low-end torque. Other Si camshafts have good low-end by sacrificing high-end punch, and the worst did nothing at all! But the most **aggravating** sacrifice has been poor idle quality. With a KMS Si camshaft you can expect a nice smooth idle with good off-idle response and a powerband starting at 2000 RPM continuing on to 6500 RPM. Proper heat-treating ensures long camshaft life, and a proper base circle gives you a quiet running camshaft. **Lift:** 386 Degrees intake/exhaust; **Duration:** 260 Degrees-intake, 280 Degrees exhaust.

### Valve Springs

When preparing your car for high RPM use, the stock valve springs have proven to be inadequate. KMS valve springs will prevent ocillation and valve spring float.

**RIGHT:**  
A King Motorsports/Mugen Power Engine  
on the dyno at King Motorsports  
engine-building facility

### Adjustable Cam Gear

When deck heights of blocks or heads are milled to achieve higher compression, cam timing is effectively retarded. The KMS Adjustable Cam Gear will enable you to bring your cam timing back into spec. Due to our unique design, these gears have proven to be totally reliable in racing use.

### Valves

KMS manufactures these ultra high quality oversize valves from stainless steel. In actual racing use, we have never had a valve-related failure. All valves are micro-polished and are lightened for the ultimate in high RPM performance. Available for 83-87 Prelude, 1200 Civic, and Integra.



## Mikuni Twin Sidedraft CRX Carb Kit

From a performance standpoint, the standard carburation on the 1.5 litre CRX/Civic is very hard to work with. When modifying your car for autocross or performance driving, it becomes necessary to change induction. The Mikuni Twin Sidedraft Carb Kit will satisfy the need for power but will also be tame enough for everyday driving. This kit will produce a very flat power band that starts at 2000 RPM and pulls to 8000 RPM. To take full advantage of the power capabilities of this kit, KMS recommends the use of a Mugen exhaust manifold and silencer with a Mugen XA-1 camshaft. This kit comes pre-assembled, complete with comprehensive installation instructions and *all* hardware. Also included are two pre-oiled K&N air filters.

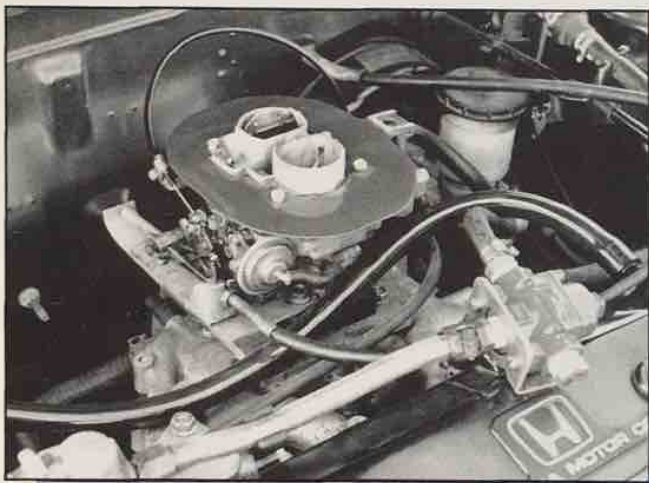

## 34/34 Weber Conversion

After you've added a Mugen header and exhaust system to your 84-87 CRX/Civic, the next logical progression in performance is the induction system. Common 32/36 Weber conversion kits have proven to be inadequate for the 84-87 CRX/Civic. First and most important is the 32/36 Weber was designed for a longitudinal engine. When used on a transverse engine, the float bowl will starve in any cornering situation. The 34/34 Weber incorporates a central float bowl to eliminate fuel starvation. This conversion also has the correct venturi size to eliminate the flat spots common to the 32/36 Weber. Linkage problems are eliminated since this setup utilizes the stock cable. Each kit comes complete with adapter plates, gaskets, properly jetted carb, and special air cleaner to bolt on to the stock manifold. 84-87 CRX/Civic Carb, SCCA IT Racing Legal.

## Special Purpose Manifolds

On special request, King Motorsports can manufacture "one-off" manifolds for special applications. Examples of these manifolds are twin Mikuni/Weber for Civic 1200 and 84-87 Prelude. Also available are slide-carb manifolds for Civic 1200. These manifolds have been developed on the dyno after hundreds of hours on the race track. They have proven to make the most horsepower. Due to the fact that each manifold is hand-made there is a three week lead time on all special purpose manifolds.

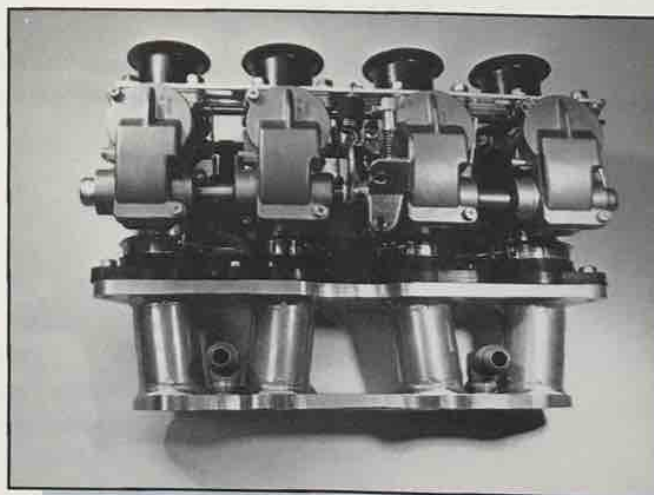





## Carrillo Rods

Typically, the weakest links in a Honda race engine are the rods. Any continuous use over 8000 RPM will usually result in rod failure. For this reason all KMS race engines use Carrillo rods, and we highly recommend them for any serious racing effort. Over a 5 year period we have not seen any rod related engine failures using Carrillo rods. All Carrillo rods come in a matched set with a tube of assembly lube. Available for 1200 Civic, 1300 Civic, CRX, Integra, and Prelude.

## KMS Crankshafts

Correct crankshaft preparation can mean the difference between a smooth, long lasting engine and a vibrating, trouble-laden engine. KMS starts with a fresh crank and magna fluxes it to test for cracks. Each crank is then cross drilled and fluted for extra oiling. The cranks are then stress relieved and all journals are micro-polished. Finally all cranks are then balanced to exacting standards. The finished product is a much stronger and smoother unit to assure you a long-lasting crank. Available for all Honda/Acura applications.

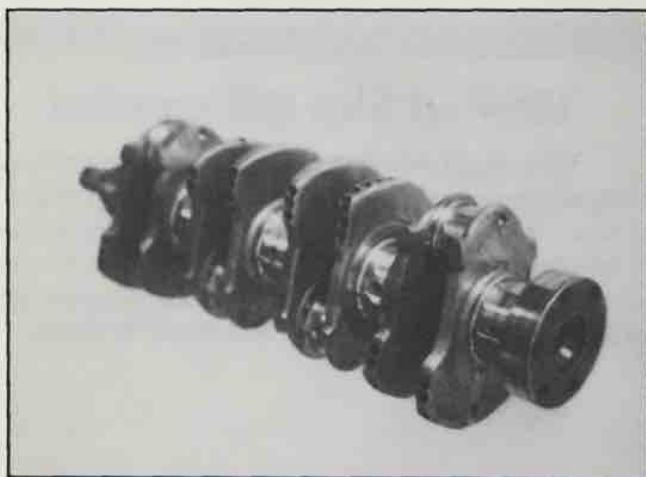

## King Motorsports Machine Shop Services

Because our machining is done "in house" we can offer these services to you. Examples of these services are: ported and polished heads, 3-angle valve jobs, engine block preparation, balancing, and fabrication. We also have a complete computer equipped Stuska dyno and can provide you with dynoed engines. Because of our vast experience, it is often less costly in the long run to have us do your preparation. This eliminates a lot of guesswork on your part and assures you of the very best, proven preparation for your competition needs. Please call us with your needs and we can provide you with price quotes and lead times.



196 hp Integra Race Motor

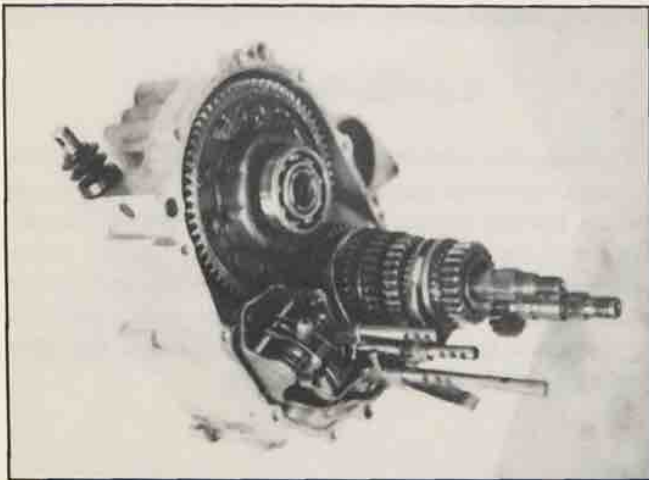

## Close Ratio Gearbox

Without the proper gearbox ratios, even the most powerful engine will mean very little. Being in the correct powerband at all times is the key to fast lap times. All KMS Close Ratio Gearboxes are made with straight cut gears for minimal power loss through the driveline and they also have a special heat treating process which makes them very durable. Due to the fact that each box is hand made, please allow a 6 week lead time for ordering. Available for Civic 1200, CRX, and Prelude.

## Limited Slip Differential

Wheelspin, whether during autocrossing or road-racing can be a very limiting factor to quick lap times. The use of a Limited Slip Differential will virtually eliminate any inside wheelspin and allow the driver to be on the power much earlier than either an open or locked differential. Available for Civic 1200 and 83-87 Prelude.

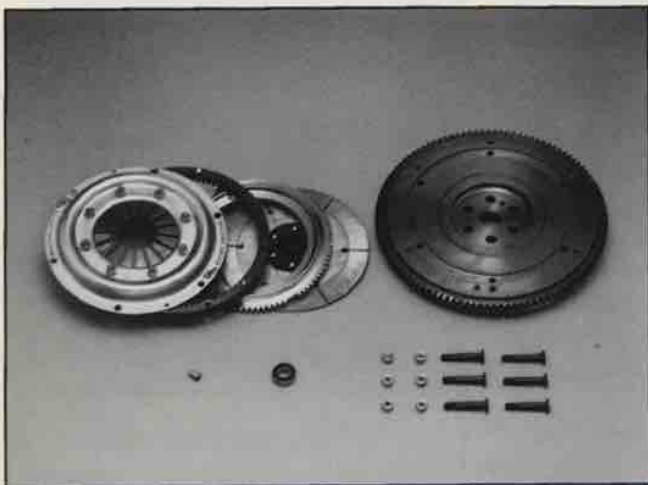

## Quarter Master

Quarter Master has become an undisputed leader in clutch/flywheel technology. KMS uses Quarter Master products in all our racing cars with great success, and no failures. Each Quarter Master clutch is designed around an ultra light billet flywheel for maximum response. The clutch discs themselves are solid discs with no springs to absorb shock, therefore they should never be considered for street use. In field use these clutch discs will last a season of 7 or 8 races before needing replacement. Available for 1200 Civic, 84-87 Civic/CRX, 83-87 Prelude, & 86-88 Integra.

## Lite Flywheels

For performance driving or autocross use, a Lite Flywheel can give tremendous results in terms of engine response and flexibility. KMS uses *new* flywheel cores and machines them to the desired weight, then balances each unit to assure you of vibration free performance. There are no negative side effects of using a Lite Flywheel other than the few extra RPM required during engagement from a standstill. Available for all Honda/Acura Applications.

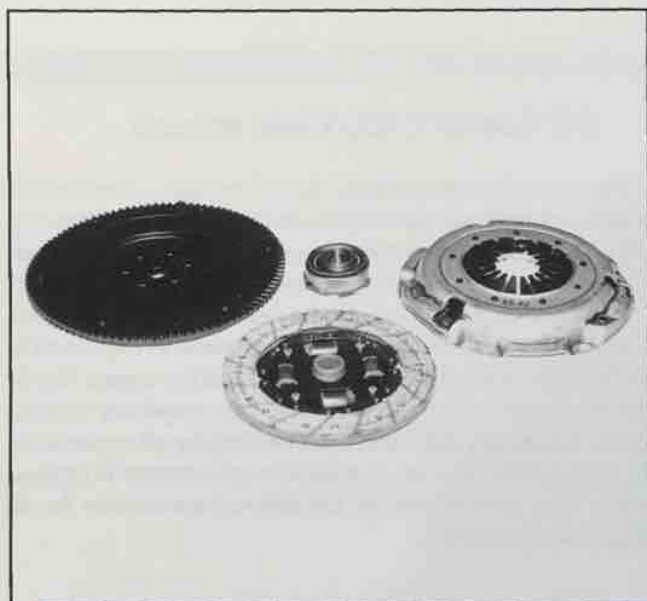

## 84-87 CRX/Civic High-Performance Flywheel & Clutch

Once this engine is producing to its potential, NO bolt-on aftermarket clutch will withstand the punishment. For this reason King Motorsports designed a flywheel to incorporate our Mugen Integra Clutch. This 10lb. ductile iron flywheel was made specifically for this application. This is not a reworked or lightened stock flywheel, but a purpose-built flywheel. The Mugen Integra Clutch offers 3 times the clamping force of a stock clutch at ALL RPMs, not just at extremely high RPMs like a Centerforce unit. It is perfect for high torque applications such as turbo or nitrous systems which cause every other clutch to slip. Complete bolt-on package with all pieces included: flywheel, disc, pressure plate, and modified throw-out bearing.

## Recurved Distributors

Honda characteristically uses a very late advance curve on all its engines. From a performance standpoint this is not adequate. KMS reworks each distributor to provide maximum advance at 2500 RPM. You will notice immediate improvement in engine response and flexibility with this unit.

Available for all Honda/Acura applications.

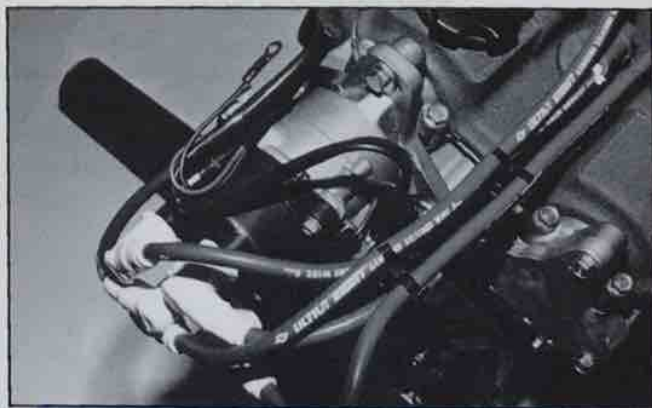

## Ultra Ignition Wire Set

The weakest link in the typical Honda ignition system is neither the distributor or coil, but the ignition wires. Maintaining a strong spark is essential for any performance application. The Ultra Ignition Wire Set is without a doubt the finest ignition wire set produced. Have you ever had an after-market set of ignition wires come apart in your hands when changing plugs? That common problem is eliminated with a special insulated boot and terminal end. These 8mm ignition wire sets are tailored to each application. Since they are sheilded, there will not be any static picked up on stereos and tape players. Minimum loss of voltage through these wires means extra horsepower to you! Available for 84-87 CRX & Si, 84-87 Civic & Si, and 86-88 Integra.

Available for 88/89 CRX/Civic

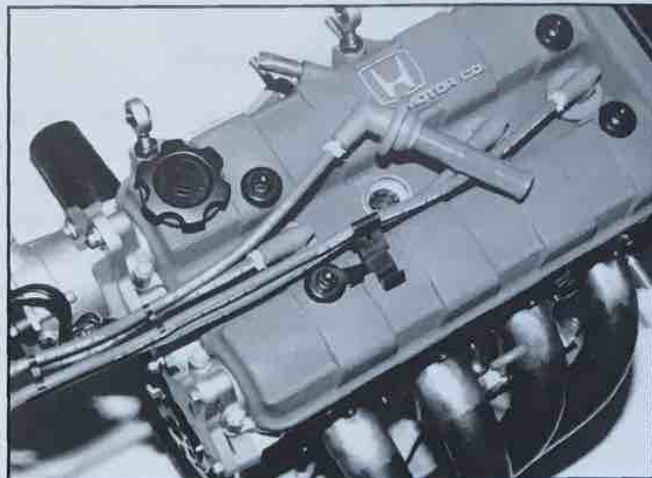

## Oil Cooler CRX/Civic w/carb

Extreme oil temperatures caused by high compression or other performance modifications combined with continuous high RPM use can lead to premature engine failure. By maintaining cooler water and oil temperatures with the use of this water cooled oil cooler, this problem can be minimized. Unlike other oil coolers which require a fragile cooler element to be placed in direct air flow, the KMS unit is mounted behind the engine block, out of harms way. This unit has proven to be completely trouble free because it is mostly self contained, no lengthy oil cooler lines to chafe and break, and no installation placement problems whatsoever. This unit should be considered mandatory for all performance applications.

## Quicksteer Rack

Getting behind on steering input during an autocross is a common problem that always results in slower times. The KMS Quicksteer rack changes the standard 3.89 turn lock to lock ratio to 3.55 turn lock to lock. No more missed cones, while maintaining a light, manageable steering effort. Available for 84-87 CRX/Civic 1.5 litre w/carb and Si.





## King Motorsports' Race-Winning GT-3 CRX

### GT-3 CRX

As a joint project between King Motorsports and Mugen, the results with this race-winning car have been fantastic! The GT-3 CRX has proven without a doubt that a high-horsepower front wheel drive race car is just as fast as a comparably-equipped rear wheel drive car, and in some cases faster. One of the biggest reasons for this car's success is the state-of-the-art engine and driveline that Mugen has produced. This combination has proven to be very powerful and absolutely dead reliable. This car has recorded six wins in National competition to date. King Motorsports is considering a production run of these cars for the 1990 racing season. If you are serious about GT-3 in 1990, please contact us for full details on this car.

### HKS Sport Exhaust Systems

For applications that Mugen does not make an exhaust system, KMS recommends and uses HKS Sport Exhaust Systems. HKS Sport Exhaust Systems are not to be confused with common "bolt-on" mufflers which do little but add noise. The HKS System is a complete tuned exhaust that is a direct bolt-on replacement, eliminating cutting, welding, or fabricating of any kind. Each system is constructed from high quality Aluminized steel to insure long exhaust life. For maximum performance in Auto-cross or performance driving, a non-restrictive pre-silencer is provided for catalytic converter replacement (off-road use only). However, for stock Auto-cross classes or for legal street use, the stock converter can be retained within the exhaust system. The HKS Sport Exhaust has an exceptionally quiet exhaust note, deep and throaty, but not objectionable.

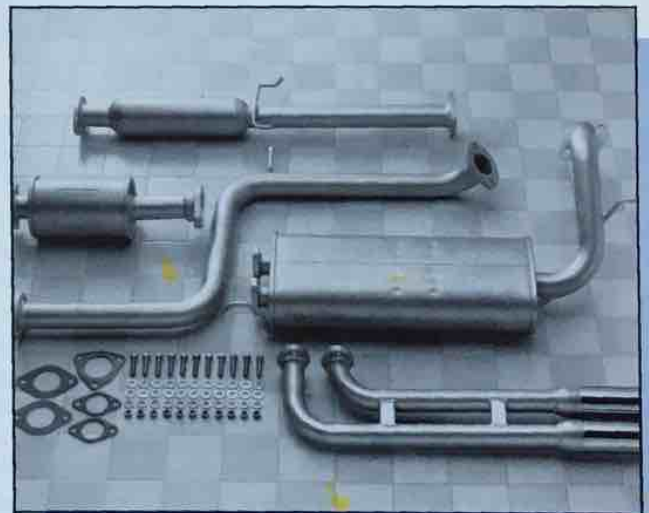

Available for: Acura Integra, 86-87; Acura Integra, 88-89; Prelude Si, 85 1/2-87; CRX Si, 85-87; Civic Si, 86-87

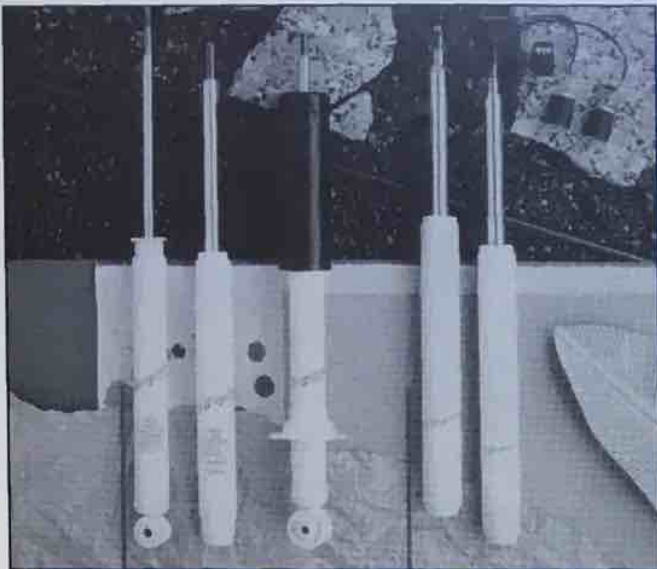

## Tokico Gas Struts

Tokico has become the leader in Gas strut technology. Tokico uses a twin tube design, which offers two distinct advantages over a conventional monotube gas strut: Low pressure and flexible valving. This combination allows the Tokico strut to have finer tuning capabilities over a wider range of speeds and deflections. In the real world this means impressive ride quality with immense gains in vehicle control. For those who wish added adjustability, Tokico offers the Illumina Strut which is externally adjustable, a big benefit for Autocross and performance driving. All Tokico struts are backed by a **lifetime guarantee**. If you're looking for a high-performance gas strut, Tokico offers unsurpassed performance. **Free shipping on all Tokico Struts!**

### APPLICATIONS

#### Low Pressure Gas

76-81 Accord	84-87 CRX/Civic
82-85 Accord	88 CRX
86-89 Accord	80-82 Prelude
75-79 1200 Civic	82-87 Prelude
75-79 Civic CVCC	87-89 Prelude
80-83 Civic	86-89 Acura Integra

#### Illumina Adjustable

84-87 CRX/Civic
88 CRX/Civic
86-89 Integra

## Sport Spring Kits

Significant improvements in handling can be had with the inclusion of a KMS Sport Spring Kit to your car. Immediately your car will react much quicker and more precisely to steering inputs. Transient and turn-in response will be noticeably improved, plus you will appreciate the lower stance and aggressive looks of your car. KMS Sport Spring Kits use a truly progressive wound spring to maintain excellent ride quality. During compression the spring rate is increased, which results in greater resistance (the spring becomes stiffer) for excellent performance driving characteristics. All KMS Sport Spring Kits use the highest quality, high-tensile Chrome Silicon Oil-Tempered spring steel available. The springs are then shotpeened for added durability and electrostatically powder coated for a superior high-quality finish. Because of these high standards, these Sport Spring Kits exceed the stringent requirements of the German TUV, a quasi-governmental authority which is fanatical about technical supervision and scrutiny. Average height reduction 1".



**Available for:** Acura Legend 4 Door, 86-89; Acura Legend Coupe, 86-89; Acura Integra, 86-89; Prelude, 83-87; Prelude, 88-89; Accord, 86-89; CRX/Civic, 84-87; CRX/Civic, 88-89.



## K&N Air Filters

While there may be no such thing as "free" horsepower, the K&N Air Filter comes very close. Ordinary paper air cleaners do an admirable job of filtering air, but clog easily, reducing air flow (CFM). A K&N Air Filter used for 40,000 miles will actually out flow a new foam or paper filter. When new, a K&N air filter flows double the amount of a foam or paper filter. K&N uses a washable cotton gauze element which is designed for the life of your engine, and will need to be cleaned every 50,000 miles. K&N engineers their filters to fit each application. K&N is so confident of their filters performance and durability, they offer a free million mile warranty with each air filter. Applications 85-87 CRX Si, 86-87 Civic Si, & 86-88 Integra.

**New Application: 88/89 CRX/Civic**



## Carbon Metallic Pads

If you have been racing the 88/89 CRX, you have probably found this car's weakest point, the brakes. Standard pads commonly will not last an entire race and then score the brake rotor. This leads to a very unsafe scenario, a race car that cannot stop! Carbon Metallic pads commonly last at least two races and at the same time provide much greater stopping power. If you race a 88/89 CRX, you should consider these pads as mandatory.

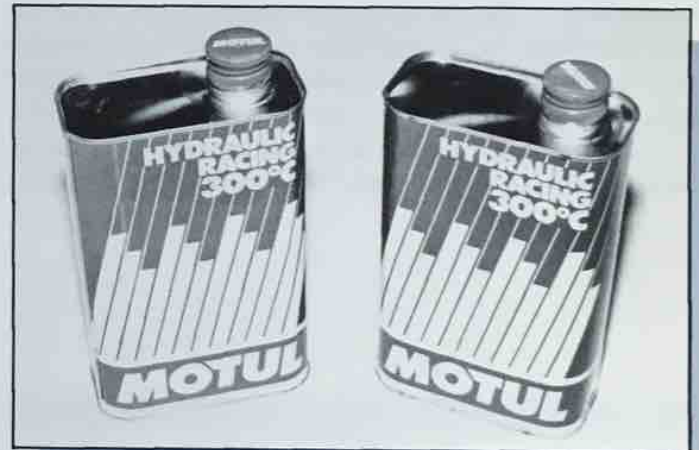

## Motul Brake Fluid

During the 1989 racing season, KMS used Motul brake fluid with great success. This DOT 3 synthetic brake fluid has an extremely high boiling point. We have also supplied this fluid to numerous endurance race teams, all having tremendous success. This brake fluid should be considered mandatory for any application involving continuous high temperature use.



## Red Line Oil

For many years King Motorsports used 50 weight petroleum-based racing oils in our engines, and were quite happy with their performance. We were urged to test Red Line Oil, and were skeptical at first. What we have discovered after two long racing seasons is that Red Line Oil lives up to every claim made by its manufacturers. We have seen a reduction in camshaft and rocker-arm wear, and main and rod bearings come out of the engine looking fresh, with no scoring or flaking. When oil temperatures reach 280 degrees and water temperatures hit 240 degrees, Red Line has protected against total engine failure. Why does Red Line lubricate better than other

oils? According to the technical director of Red Line, one of the keys is the adaptation of jet turbine lubricants to perform in automobiles. Red Line utilizes polyol ester base stocks in all their projects, which are the only base stocks which can adequately lubricate in the intense heat of modern jet engines. Although the average oil temperature which a race car sees is considerably lower than those seen in jet engines, the temperatures in high-pressure contact zones such as bearings, cams, and lifters may see temperatures of up to 200 degrees Fahrenheit above the oil sump temperatures. The upper ring area sees temperatures in the range of 600 degrees Fahrenheit. At these temperatures petroleum oils no longer have adequate lubricating properties. A good synthetic oil can properly lubricate at temperatures up to 700 degrees Fahrenheit. This ability to lubricate hot metal is especially important in hot-running, high-performance engines. The increased stability of Red Line Oils enables them to last substantially longer than petroleum-based oils. We must say we are completely impressed with these products and recommend them not only to racers, but to people who want to be assured of the very finest oil available.

**MOTOR OIL: 10/40, 20/50**  
**RACING OIL: 30 weight, 40 weight**  
**TRANSMISSION OIL: MTL**  
**FUEL INJECTOR CLEANER: SI-1.**

## New Mugen Decals & Emblems

Display the new bold and distinctive Mugen Logo on your Honda/Acura with these new Mugen emblems and decals.

- Small Silver Emblem:** 90000-Y28-0002-S
- Large Silver Emblem:** 90000-Y28-0002-L
- Small Silver Decal:** 90000-Y25-0041-S
- Large Silver Decal:** 90000-Y25-0041-L
- CRX Side Decal Silver:** 90000-Y25-0045-S
- CRX Side Decal Black:** 90000-Y25-0045-B
- Civic Side Decal White:** 90000-Y25-0048-W





## Genuine Honda and Acura Parts & Accessories

King Motorsports is offers considerable savings on the purchase of O.E.M. replacement parts and accessories. O.E.M. Honda and Acura parts are superior in performance, durability, and fit to common aftermarket products. When ordering O.E.M. parts please include year and model of your car, whether it is a 4-speed, 5-speed, or automatic, and your chassis V.I.N. number. This number is located on top of the driver's side of the dashboard, where the dashboard and the windshield meet and can be easily located by looking through the driver's side of the windshield from the outside. The prices King Motorsports offers are 15 to 20% less than over the counter dealer prices. Since listing the prices of all the available replacement parts would take the space equivalent to a metropolitan phone listing, please call us with your parts list and we will be happy to give you prices or any other information you require.

### *Fast Moving O.E.M. Replacement Parts*

**Oil Filters    Air Filters**  
**Spark Plugs    Fuel Filters**  
**Valve Cover Gaskets**  
**Wiper Refills    Oil Drain Plugs**  
**& Gaskets    Head Gaskets**  
**Engine Gasket Sets**  
**Brake Pad Kits**



# ORDERING INFORMATION

## HOURS

King Motorsports is open Monday through Friday from 9:00 a.m. to 5:00 p.m. Central Standard Time. Often we are at the shop after hours and weekends, if we are at the phone we will gladly answer it and help you in any way we can.

## ORDERING PROCEDURES

The easiest, most convenient way to order is by telephone. We accept VISA and MASTERCARD. C.O.D. orders require CASH or CERTIFIED CHECK, NO PERSONAL CHECKS will be accepted. No exceptions. Mail-in orders paid by personal checks will not be shipped until cleared by our bank (allow up to 14 days). When mailing in an order, please use the King Motorsports order form provided. If you don't have an order form please give us a complete description of the part and cost. Your mailing address (no P.O. Boxes), method of payment, *daytime* phone number, complete description of vehicle — year, model, standard or automatic, and VIN number.

## SHIPPING

King Motorsports uses UPS as our main carrier. UPS is the quickest, most economical way to ship. UPS has three ways to send your parcel: Standard Ground, 2nd Day Air, and Next Day Air. Please specify the way you would like your parcel to be sent. If not specified, all parcels will be sent standard ground service. Shipping times vary but are usually 3-7 working days to the East Coast, 5-7 working days to the West Coast, and 2-4 working days for the Mid-western states. All prices are F.O.B. and *do not* include shipping. All incurred shipping costs are the responsibility of the consumer. All items too large for UPS, such as fiberglass and exhaust systems are shipped by truck. Most orders taken before 2:00 p.m. (CST) are shipped the same day and at no extra cost. If, for any reason your order is returned to us as undeliverable (this includes not in on three delivery attempts, nonpayment and refusals) will be "frozen" until delivery costs incurred have been paid.

## RETURNS

All returns must be authorized by King Motorsports within 30 days of the invoice date and must be sent prepaid — NO EXCEPTIONS. A 20% restocking charge will be assessed at our discretion depending on reason for return. All returned products must be in new, unused condition.

## SHIPPING ERRORS

If you have received an incorrect item due to our error, you must notify us within 15 days of the invoice date. We will then send a UPS "call tag" to pick up the product with no cost to you, and immediately ship the correct product to you. At this time we will bill your charge card for this product and upon receipt of the wrong product, credit your account.

## CLAIMS FOR DAMAGED SHIPMENTS

All products leave King Motorsports boxed correctly and are in undamaged condition. Upon receiving your shipment *inspect immediately* in the presence of the carrier. All damage claims are the sole liability of the carrier. King Motorsports is in no way responsible for damage incurred during shipping. All claims for damaged goods must be made with the carrier.

## BACK ORDERS

Because of the limited production of Mugen components availability cannot be guaranteed. In the event something on your order is temporarily out of stock, we will place that item on back order and try to notify you of an approximate shipping date. If you do not want an item back ordered, please notify us of this and we will gladly cancel back ordered items.

## WARNING—READ BEFORE PURCHASING

A vehicle modified by the use of competition parts may not meet the legal requirements for use on public roads. It is your responsibility to comply with federal, state and local laws prior to vehicle use on public roads. Use or installation of competition parts may also affect or eliminate your insurance coverage. It is your responsibility to determine any change in coverage.

Competition parts are sold "as is" without any warranty of any type. There is no warranty stated or implied due to the unusual stress placed on competition parts and our inability to monitor their modification, installation or use. The entire risk of quality, performance or defect is with you the buyer. Should any part prove defective, for any reason or under any circumstance, you the buyer and not the manufacturer, distributor or retailer assumes the entire cost of all necessary repair or service and any and all consequential damage, cost or charges or any other liability.

**KING**  
Motorsports



Text & Production by Scott Zellner



  
**KING**  
*Motorsports*